

Muting Controller for Safety Light Curtain

F3SP-U4P

- High functionality (two independent muting functions, override function, automatic and manual reset).
- Category 2 or 4 depending on safety light curtain.
- Only 45 mm width
- Double output safety relay.
- 6 LED for status and diagnostics.
- Detachable terminals for easy installation.
- Controls 1 or 2 safety light curtains
- TÜV approved

Muting controller for one or two Safety Light Curtain.

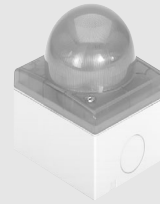
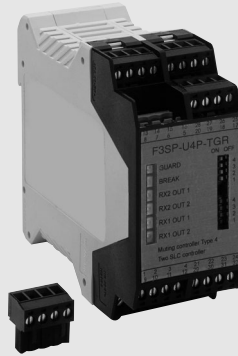

List of Models

Controller

| Description | Model |
|---|--------------|
|  Muting Controller for Safety Light Curtain F3S-B, F3SN and F3SH | F3SP-U4P-TGR |

Accessories

| Description | Model |
|---|---------|
|  Muting lamp | F39-A11 |

Rating / performance

| | F3SP-U4P-TGR |
|----------------------|---|
| Power supply voltage | 24 VDC ±10% |
| Power consumption | 420 mA max. (excl. SLC power consumption) |
| Output contacts | 2 NO 2,5 A (protected by fuse) |
| Indicators | 6 LEDs for status and diagnostics. |
| Enclosure rating | IP20 |
| Terminal | 32 screw terminals (1,5 mm ²), detachable blocks with 4 screws each |
| Response time | ≤30 ms |
| Ambient temperature | Operating: -10 °C +55 °C |
| Housing material | Plastic, DIN rail mounting |
| Weight | 0,6 kg |

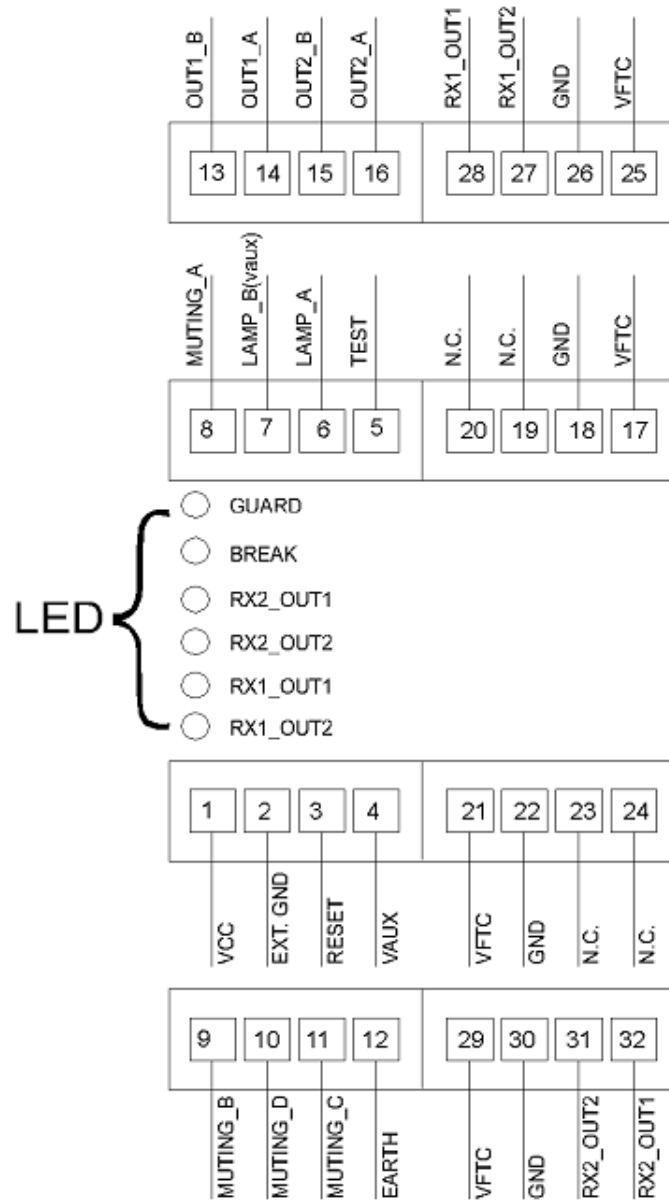

Wiring Example

Control unit F3SP-U4P-TGR in a mixed configuration that allows the use of several OMRON safety light curtains and perimetrical guards.

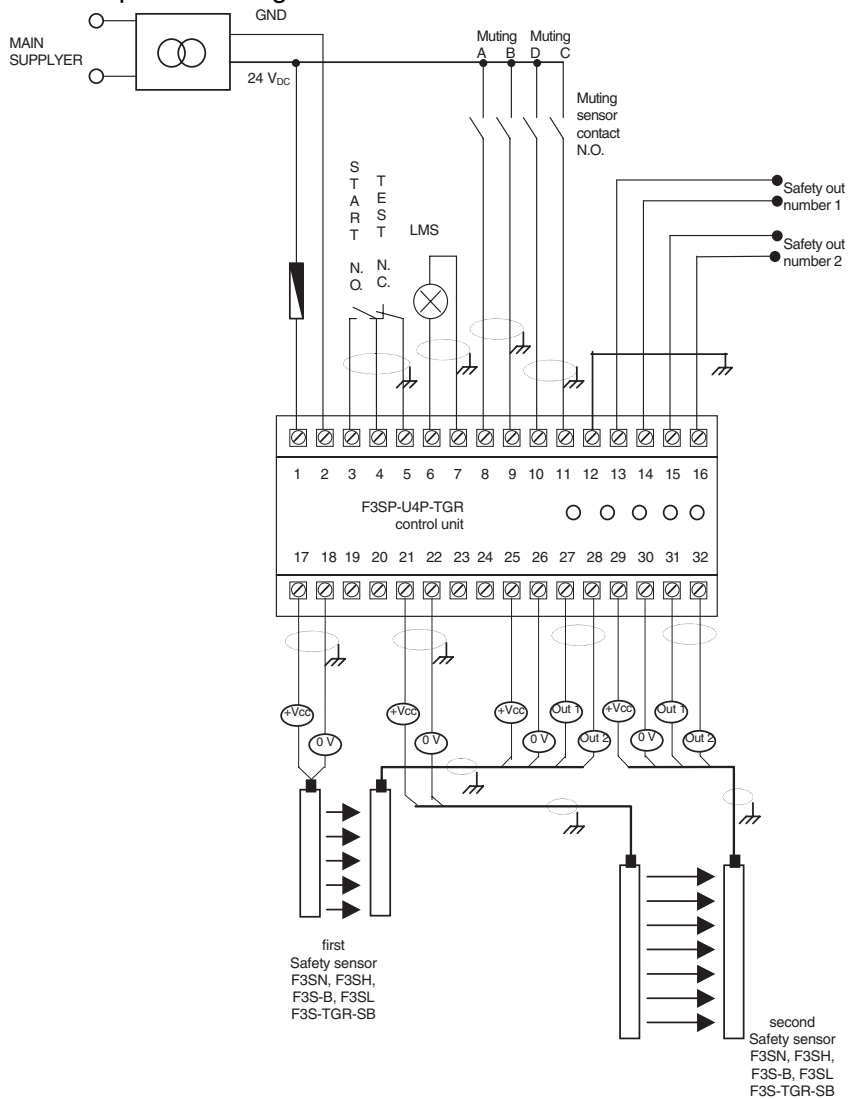

Dimensions

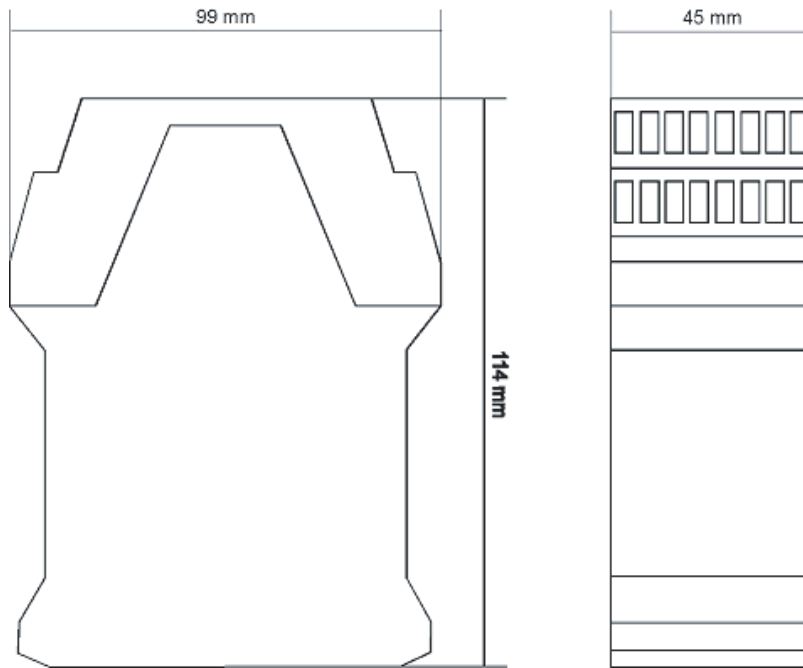

ALL DIMENSIONS SHOWN ARE IN MILLIMETERS.
 To convert millimeters into inches, multiply by 0.03937. To convert grams into ounces, multiply by 0.03527.