

Vacuum Sensor E32-V

- The 4-CH multi-flange contributes to conserve vacuum chamber space.
- One-touch fiber installation significantly reduces man-hours (4-CH flange).
- The fiber unit for outside can be freely cut on both ends, thus avoiding messy routing.
- A screw-type 1-CH flange is also available.
- Heat-resistant vacuum fiber is also available for high-temperature environments.

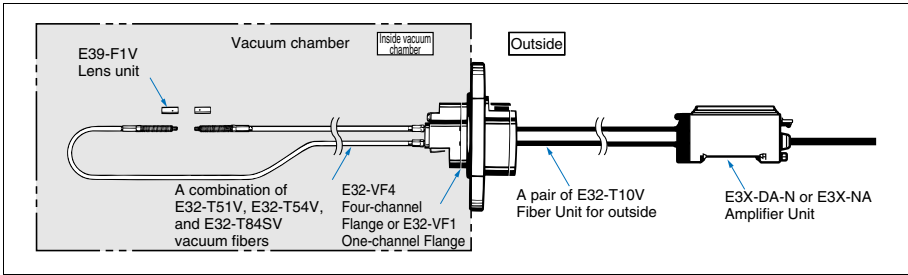



Configuration (typical example)



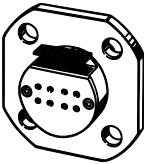

Ordering Information

Sensors

Flanges

Shape	Item	Model
	4-CH flange	E32-VF4
	1-CH flange	E32-VF1

Vacuum Fibers

Shape	Item	Model *
	Through-beam, straight model	E32-T51V 1M
	Through-beam, L-shaped model	E32-T54V 1M
	Through-beam, Heat-resistant model	E32-T84SV 1M

* A 0.5-m type is also available. Please inquire for more information.

Fiber Unit for Outside

Shape	Item	Model
	General	E32-T10V 2M

Accessories (Order Separately)

Mounting Brackets

Shape	Model	Quantity	Remarks
	E39-L54V	2	Can be used with the E32-T54V.

Lens Unit

Shape	Model	Quantity	Remarks
	E39-F1V	2	Long distance lens unit: Can be used with the E32-T51V and E32-T54V.

Rating/Performance

Flanges

Number of channels	4	1 CH	
Item	Model	E32-VF4	E32-VF1
Leakage	1 x 10 ⁻¹⁰ Pam ³ /s or less		
Ambient temperature	Operating/storage: -25 to +55°C		
Material	Aluminum (A5056)	Stainless steel (SUS304) Aluminum (A5056)	
Flange seal material	Fluoroelastomer (Viton)		
Weight (Packed state)	Approx. 280 g	Approx. 240 g	

Fiber Unit for Outside

Sensor type		Fiber Unit for Outside
Item	Model	E32-T10V
Standard length	2 m (free cutting allowed)	
Ambient temperature	Operating/storage: -25 to +70°C	
Permissible bending radius	25 mm min.	
Weight (Packed state)	Approx. 170 g	
Material	Core	Acrylics
	Sheath	Fluororesin
	Protection tube	Black polyethylene

Vacuum Fibers

Sensor type		Vacuum-side fiber transmission type			
Item	Model	E32-T51V	E32-T54V	E32-T84SV	
Standard length	1 m (no free cutting)				
Sensing distance	When using the E3X-DA-N	Super long-distance mode:	250 mm	200 mm	600mm
		Standard mode:	200 mm	130mm	480mm
		Super high-speed mode:	70mm	50 mm	180mm
	When using the E3X-NA	100 mm	65mm	250 mm	
Ambient temperature	Operating/storage: -25 to +120°C			Operating/storage: -25 to +200°C	
Admissible bending radius	30 mm min.			25 mm min.	
Weight (Packed state)	Approx. 180 g	Approx. 170 g	Approx. 180 g		
Material	Core	Quartz		Optical glass	
	Sheath	Fluororesin		Optical glass	
	Protection tube	Fluororesin		Stainless steel (SUS304)	
	Fiber head/Connection tube	Aluminum (A5056)	Stainless steel (SUS304)		

Lens Unit

Item		Sensor type	Long-Distance Lens Units	
		Model	E39-F1V	
Applicable Fiber			E32-T51V	E32-T54V
Sensing distance	When using the E3X-DA-N	Super-long-distance mode:	1280mm	630mm
		Standard mode:	1000mm	500 mm
		Super-high-speed mode:	360mm	250 mm
	When using the E3X-NA		600mm	390mm
Ambient temperature		Operating/storage: -25 to +120°C		
Weight (Packed state)		Approx. 5 g		
Material	Housing	Aluminum (A5056)		
	Lens	Optical glass		

Precautions

Important

Mounting

Cleaning

Although Flanges, Vacuum Fibers, and Lens Units are cleaned before shipping, clean them with alcohol before use in high-vacuum chambers to make sure there is no foreign matter on them.

Pulling and compression

Do not expose the fiber unit to pulling, compression, or other undo force (29.4 N or less).

Miscellaneous

Application

This vacuum-proof fiber unit is used to detect various types of work in a high-vacuum and 120°C (in parts 200°C) high-temperature chamber (vacuum chamber).

Dimensions (Unit: mm)

Sensors

Flanges

E32-VF4

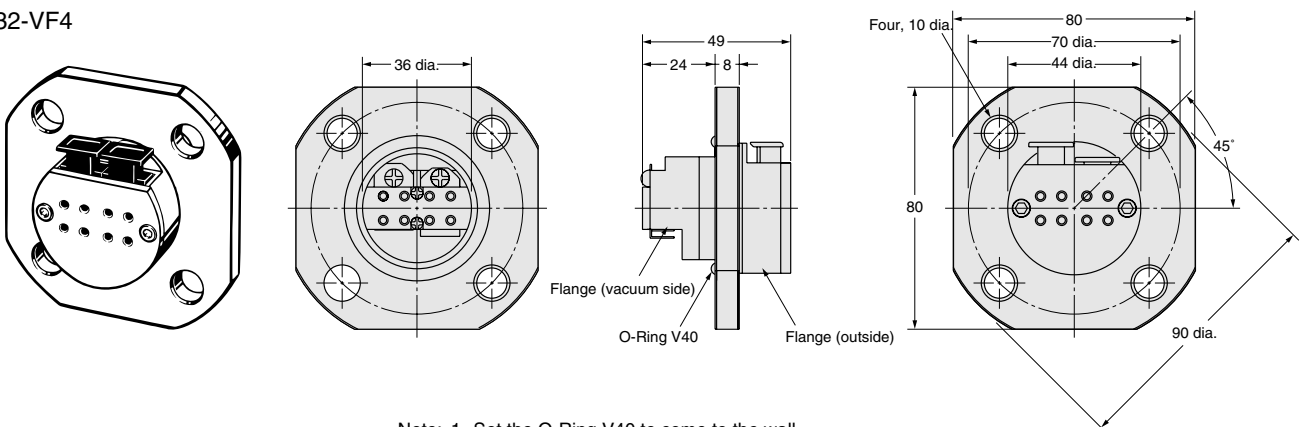

- Note: 1. Set the O-Ring V40 to come to the wall of the vacuum chamber on the atmosphere side.
 2. Mounting hole: 38±0.5 mm

E32-VF1

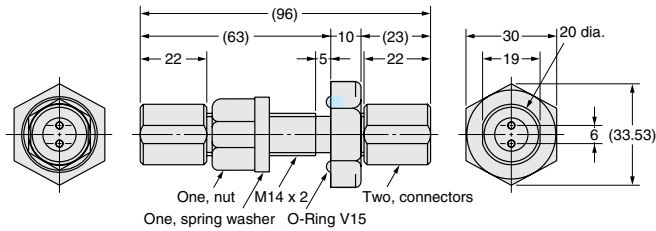
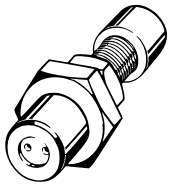

- Note: 1. Set the O-Ring V15 to come to the wall of the vacuum chamber on the atmosphere side.
2. Mounting hole: 14.5±0.2 mm

Vacuum Fibers

E32-T51V

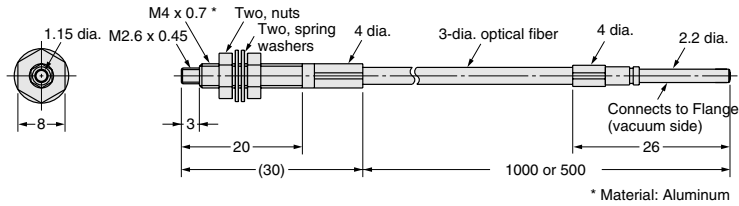

E32-T54V

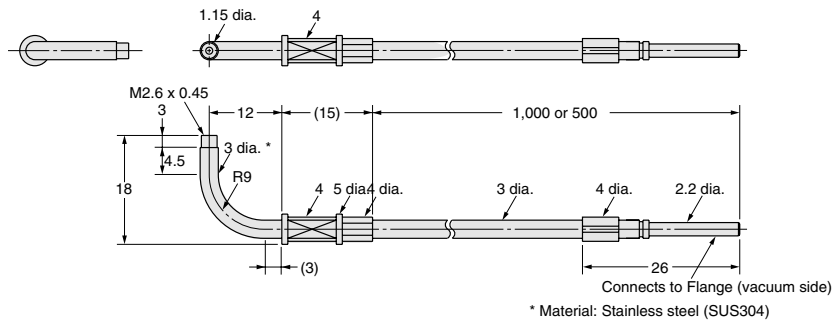

E32-T84SV

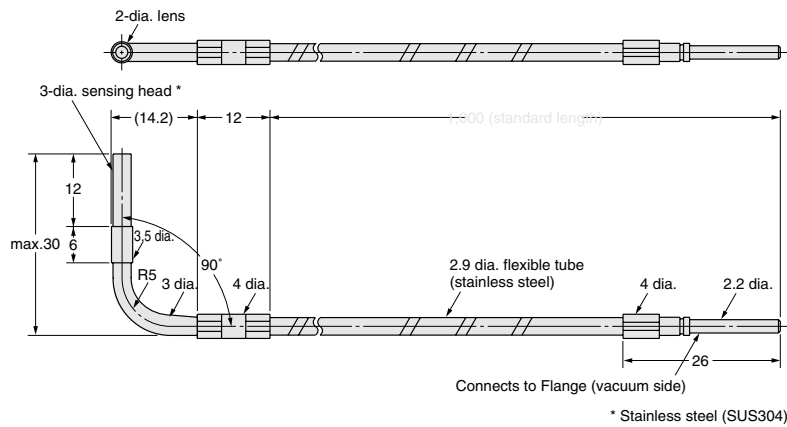

Fiber Unit for Outside

E32-T10V

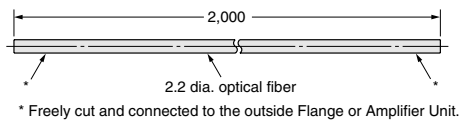

Accessories (Order Separately)

ALL DIMENSIONS SHOWN ARE IN MILLIMETERS.
To convert millimeters into inches, multiply by 0.03937. To convert grams into ounces, multiply by 0.03527.