



**GENERAL CATALOGUE 2004**

# Motion & Drives



- Motion Controllers
- Servo Systems
- Frequency Inverters
- Software

Advanced Industrial Automation

Cat. No. Y203-EN2-01 DRIVES

**OMRON**

**WELCOME TO OMRON-YASKAWA'S WORLD OF MOTION**

# **WE MAKE IT EASY**

With over 100 years of experience in motion and automation manufacturing between them, Omron and Yaskawa offer the best in class solutions. Omron, with its proven pioneering technologies in sensing and control and Yaskawa with its leading edge technology in servo and inverter technology and robotics, make it your safest option for a reliable and long term partnership. Omron-Yaskawa will also support your global business through a network of over 200 offices world-wide. Welcome to Omron's motion and drives catalogue, a world of innovation.



**2** Product Positioning

**30** Product Selection Table

**33** Catalogue Content

Application ↑

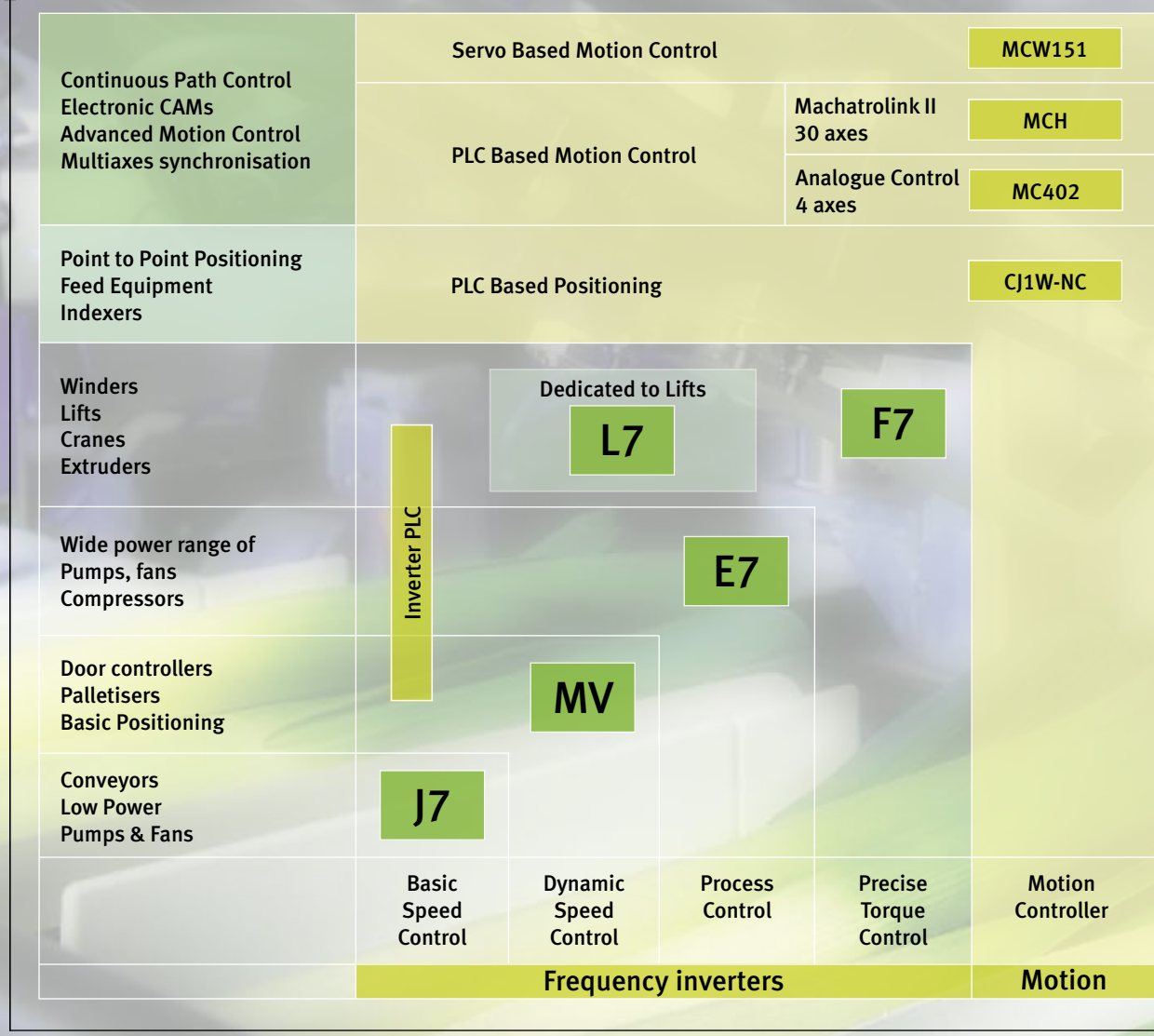

## Advanced Industrial Automation

# MOTION & DRIVES: SCALABLE, FLEXIBLE, EASY AND

### Motion controllers: Machine flexibility & scalability made easy

Omron's range of motion controllers offer the programming simplicity without compromising on system performance. Functions like axes interpolation, master-slave, e-cam and now multi-axes synchronisation over a digital servo-link are readily available.

Hence demanding applications like high speed packaging, precision electronic assembly, wood-profiling machinery, plastic injection moulding,

etc. are all easily performed. Omron's range of motion controllers offer a choice of being PLC or servo based. Hence offering you optimum machine flexibility and scalability.

### Servodrives: Unequaled reliability

Omron Yaskawa's range of servodrives are unique in offering the highest dynamic performance in the most compact size. Add to that an unparalleled reliability and you begin to understand why our range of servo's enjoy the largest installed base world-wide. The SmartStep series is aimed

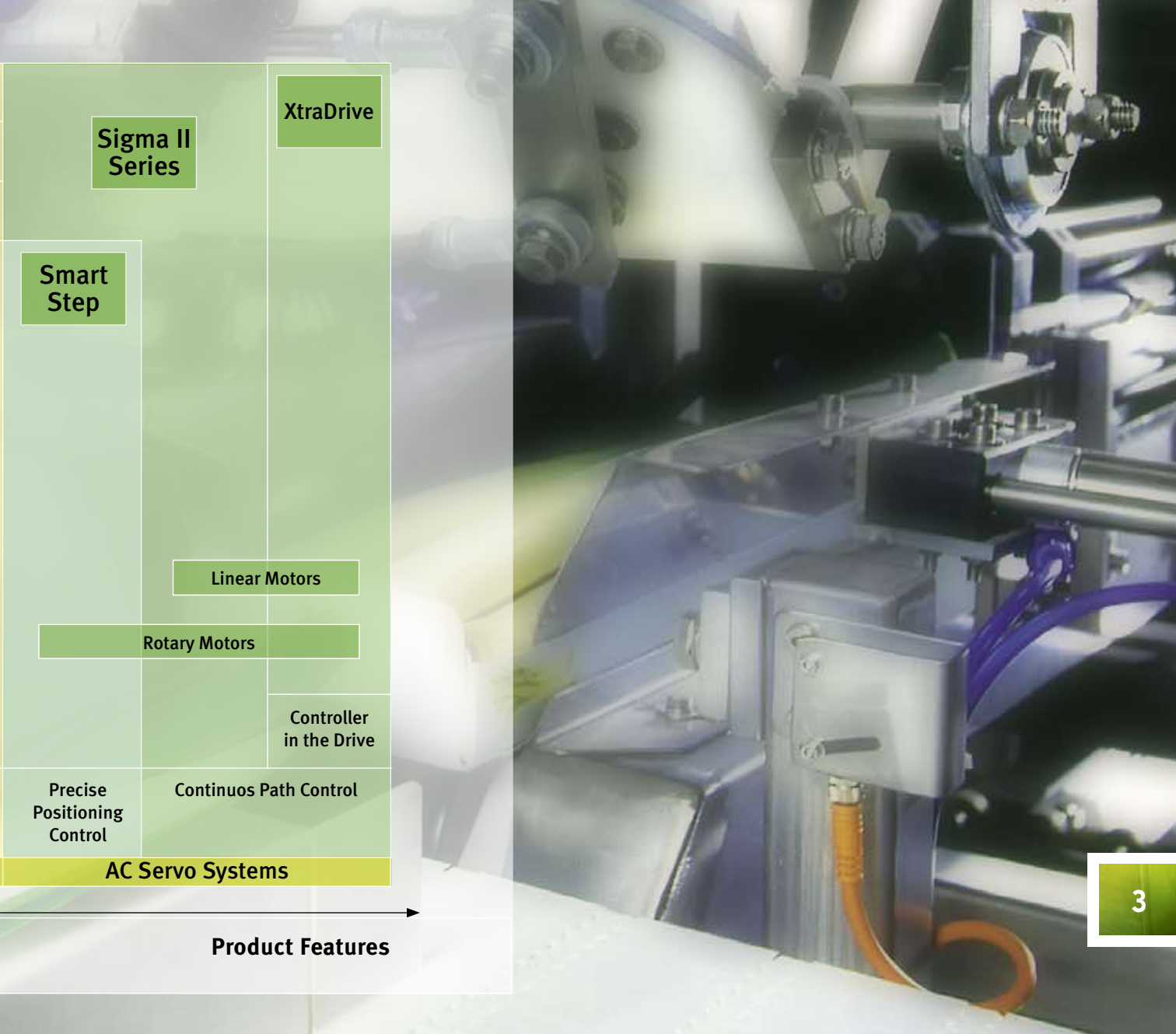

## ABOVE ALL, RELIABLE

at stepper motor applications, whilst the Sigma-II series is a dynamic servo range made for high precision positioning and higher duty operation. The Sigma-II series includes rotary motors from 30W to 55kW and linear motors up to 10,000 N. The servo amplifiers are available as standard with analogue and pulse inputs, and options allow fieldbus connectivity including Mechatrolink.

### Frequency inverters: Setting higher standards

Building on Yaskawa's world leading innovative design principles, the latest impressive range of

inverter drives boasts everything from the micro J7, to the rugged mini V7, up to the full flux vector drive F7.

The power range is from fractional horsepower right through to 300kW. The latest releases also include market specific inverters like the E7 for HVAC applications and the L7 for the lift market. Needless to say, a host of option units are available to provide comprehensive connectivity to popular fieldbuses such as DeviceNet, Profibus and CAN.

## MULTI-AXES MOTION CONTROL GOES "ALL DIGITAL"

CS1-MCH • Up to 30 axes positioning via Mechatrolink motion bus.



4

The CS1-MCH fulfils the ultimate need in advanced motion control. It combines the accuracy, simplicity and functionality of a true multi-axes unit and the full transparency down to the motor that a digital servo-link should provide.

The MCH allows full synchronisation of up to 30 axes over the field proven Mechatrolink bus, greatly simplifying system wiring, improving noise immunity and significantly reducing the chance of wiring errors. The

network cycle time of the Mechatrolink-II is as low as 500 $\mu$ s in a typical multi-axes configuration. The functionality also includes comprehensive features such as master-follower, e-cam, linear and circular interpolation as well as print registration. All are programmable via a motion BASIC language.

The MCH is the ideal motion controller for high speed packaging, electronic assembly, continuous path profiling and many other applications.

### Features CS1W-MCH

- PLC-based motion controller
- Complete digital control of drives via Mechatrolink II
- Controls a total of 30+2 axes
- Simplified wiring saves cost and design time
- Real multi-tasking and parallel programming
- Simple to develop and modify using BASIC
- Access to the complete system from one point
- Linear and circular interpolation
- Electronic axes synchronisation
- Electronic CAM profiles
- One hardware registration per axis
- Dedicated inputs / outputs on the controller
- All features of the Sigma-II Series Servo Drives are available



- ▶ Mechatrolink is a digital servo bus that provides the user with a system that reduces system wiring complexity and hence saves valuable time during installation and commissioning.

## ADVANCED MOTION... INTUITIVELY



R88A-MCW151 • Servo-based motion controller



C200HW-MC402 • PLC-based motion controller



Both the PLC-based MC402 and the Servo-based MCW151 motion controllers are multi-tasking and programmable with the same user friendly Motion Perfect Windows programming tool, which also provides very helpful debugging. The BASIC type programming language has a complete command set, allowing applications such as flying shears, rotating knives or any synchronisation and Electronic CAM to be easily programmed. The MCW151 is an advanced motion controller option unit for the Sigma II Series drives. It connects directly to the servo drive, acquiring complete access to all driver parameters and functions. It provides network connectivity,

and an additional encoder input/output allows the Sigma II Series servo system to be synchronised with any process. An integrated HostLink protocol allows easy connection of peripheral devices such as PLCs and NT terminals. An additional variant with a DeviceNet interface is also available.

The MC402 is a PLC-based advanced motion controller. It controls 4 axes and up to 16 modules can be installed in the same PLC. The module controls the position, speed or torque of the servo drive via an analogue output, and its PLC-based condition opens the controller to the whole system.

**Features R88A-MCW151**

- Sigma II Series servo based Advanced Motion Controller
- Connects directly to the Sigma II Series, providing access to all driver parameters
- Controls 1 real axis, 1 virtual axis and a configurable third axis
- Provides an additional encoder Input/Output to the servo drive
- Provides 2 additional hardware registration inputs
- Network Connectivity via HostLink or DeviceNet

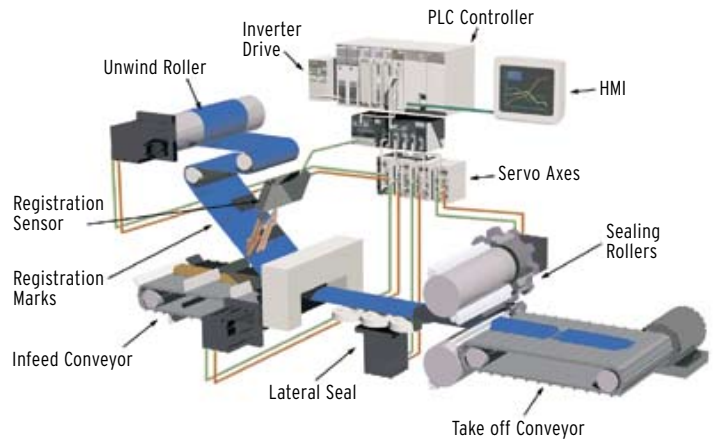

**Common features**

- Multi-task BASIC motion control language
- Programmed using Windows-based Motion Perfect software with debugging, monitor and oscilloscope functions
- Speed and torque control
- Dedicated inputs/outputs on the controller
- Linear and circular interpolation
- Electronic axes synchronisation
- Electronic CAM profiles

▲ **Flow wrap machine**

The flow wrapper machine requires various servo axes working in synchronisation. The PLC-based MC402 is the ideal solution. It provides a centralised motion control while seamlessly integrating with different parts of the system.

▼ **Motion Perfect software**

Friendly and powerful software for programming and debugging. Programming is done in a BASIC type language. Motion Perfect provides versatile test and monitoring functions including a 4-channel software oscilloscope to display the selected signals.

**Features CS1W-MC402**

- PLC based Advanced Motion Controller
- Analogue output control of the servo drives
- Controls 4 real axes and 4 virtual axes
- 4 hardware registration inputs

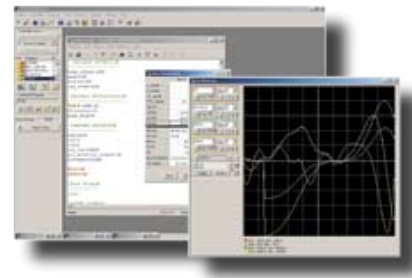

- ▶ A single MOVE-LINK instruction in the MCW151 ensures perfect synchronisation between the film wrapper and the feeder conveyor.





## POINT-TO-POINT POSITIONING IN NANO SIZE

### CJ1W-NC • 4 axes PLC-based position controller



8

For Point to Point (PTP) applications The CJ1W-NC range combined with the CJ1 PLC offers the best performance/size ratio on the market. There are 3 models with 1, 2 or 4 axes capability, with the ability to handle up to 100 positions and a pulse rate of 500kbps.

The motion commands can be set directly from the PLC ladder program making it simple and easy to use. The NC units are ideal for all PTP applications such as pick & place, gantry robots, electronic assembly, labelling stations, etc.

**Features CJ1W-NC**

- PLC based Positioning Controller
- Pulse Train Output (1pps to 500kpps)
- Available units for 1, 2 and 4 axes
- Dedicated inputs / outputs on the unit
- Positioning can be done by direct Ladder commands
- Positioning of 100 points done from memory
- Position and speed control
- Linear interpolation
- Interrupt feeding function
- Origin search, S-curves, Backlash compensation, Teaching and other common functions are available
- CX Position Support software for easy data set-up



**Assembly systems**

A list of interpolated or individual moves can be executed directly from the unit memory, up to 100 points per axis can be stored in the positioning unit. Direct operation and forced interrupt operation can be easily programmed in the PLC.

**Feeders**

Feeder applications can be easily solved using the feeding function, the axis can be moved a specified amount after the interruption signal. S-curve acceleration/ deceleration improves feeding precision while reducing slipping.

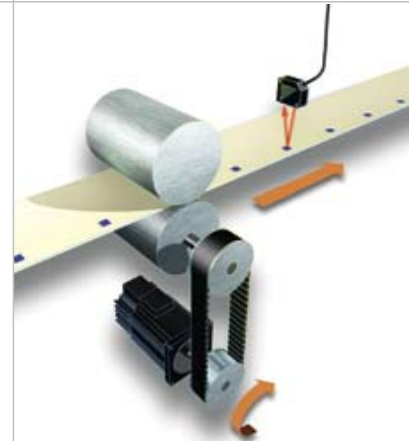

- ▶ A high-precision positioning system can be constructed to meet a broad range of applications by combining the Position Control Unit with a high-speed, high-precision Omron servo motor and servo driver.

**Software:**

CX- Position provides easy data input, editing, transfer, saving and printing, as well as status monitoring.

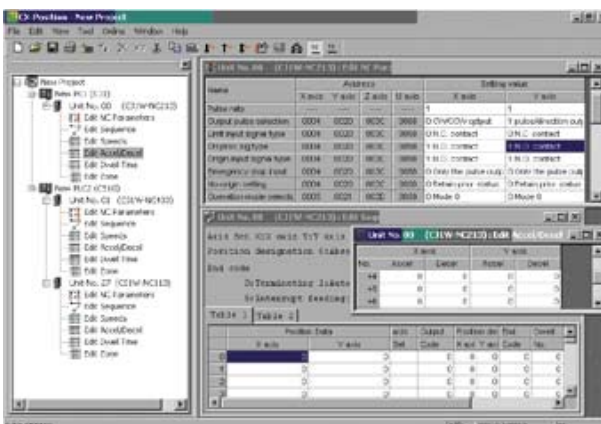

**SYSMAC CJ-series**  
Programmable Controller



**Position Control Unit**  
CJ1W-NC113 or CJ1W-NC133 (for 1-axis control)  
CJ1W-NC213 or CJ1W-NC233 (for 2-axis control)  
CJ1W-NC413 or CJ1W-NC433 (for 4-axis control, available soon)



**SMARTSTEP Series**  
R7D-APA  
Servo Driver

- External input (1 to 4 axes)
- CCW limit input
- CW limit input
- Origin proximity input
- Emergency stop input



**SMARTSTEP Series**  
R7M-AP  
Servomotor

# SERVO DRIVES DESIGNED WITH ZERO COMPROMISE

Sigma-II Series • When reliability and size matter



The Sigma-II servo series was designed with ZERO compromise on quality, reliability or performance. The motors come in an IP67 housing, making them suitable for use in the most demanding environments.

The servo amplifiers are ultra-compact with pulse and analogue inputs as standard, plus an auto-tuning function that ensures set-up time is minimised.

Plug-on option cards offer enhanced functionality, including Point-To-Point indexing and master/slave synchronisation, plus fieldbus connectivity including Mechatrolink and sercos. The Sigma series power range spans from 30W up to 55kW in speeds up to 6000rpm.

- Output range from 30W to 55kW
- Rated motor speeds from 1000 rpm to 6000rpm
- Motor protection class IP67
- Peak torque 300% of nominal
- Analogue control for speed and torque
- Pulse train control for positioning
- Encoder resolution up to 17 bits
- Incremental and Absolute encoder
- On-line auto-tuning with 10 levels of rigidity
- 2% torque precision
- Hardware registration Input
- Automatic motor recognition
- Optional Units for system openness
- Easy to connect with pre-assembled cables
- Configuration and commissioning via SigmaWin tool
- Easy design using the Motor selection tool

▶ **Motor Selection Software**

With the sizing software package you can design your machine and the software will size your required Sigma-II Series servo motor.



▶ **SigmaWin Software Tool**

In addition to easy configuration and parameter setting of the servo, SigmaWin provides advanced monitoring features, like the oscilloscope, for fast commissioning.

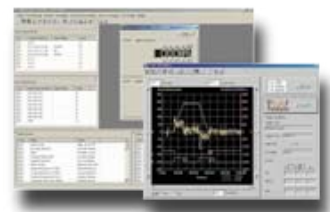

▶ **Printing tiles using a rotary print process**

The machine uses printing techniques to print patterns onto ceramic tiles. The procedure must be very accurate, as the tile has to go through the same process four times, one for each of the primary colours plus black. This is solved using the Sigma-II Series servo system because its dynamic performance and control features meet all the application requirements.



▶ **Openness and flexibility**

The Sigma-II Series drive is compatible with any system in the world via the Dual-Port RAM interface.

The following option units are available:

- R88A-MCW151(DRT)-E Servo Based Advanced Motion Control Unit. DeviceNet connectivity is available.
- JUSP-NS300 DeviceNet Option Unit with positioning functionality.
- JUSP-NS500 Profibus Option Unit with positioning functionality.
- JUSP-NS600 Indexer Unit. Versatile point-to-point positioning.
- JUSP-NS115 Interface Unit for Mechatrolink II. Multi-axes wireless solution.



# SERVO CAPABILITY WITH STEPPER SIMPLICITY

SmartStep • Smart alternative to stepper motors



SmartStep is designed and engineered to provide you with an easy way to migrate from steppers to servos in minutes. It accepts pulse train input, can be configured quickly via simple dip switches and has an on-line auto-tuning function. Thus the SmartStep offers all the simplicity and cost-effectiveness of a stepper with the added advantages of the servo drive capability. As such, continuous torque over nominal speed, 300% peak torque, 4500 rpm peak speed and a 1000:

1 speed range are all available from the SmartStep, giving the user true servo performance. The SmartStep is available in sizes from 30 to 750W. For applications like labelling stations, pick & place, indexing and transfer stations the Smart-step, coupled with the CJ1W-NC range, provide an extremely cost effective solution. Pre-wired cables and ready-made programming libraries ensure installation and commissioning time is reduced to a minimum.

## Features SmartStep

- Output range from 30 W to 750 W
- Rated Motor speed of 3000 rpm, peak 4500 rpm
- Peak torque 300% of nominal
- Control via pulse train (speed and position)
- Position Resolution of 8000 steps per revolution
- On-line auto-tuning with 10 levels of rigidity
- Dynamic brake setting
- Simple start-up possible with DIP switches
- Diagnostic code display
- Easy to connect with pre-assembled cables
- Oscilloscope available via SigmaWin tool
- Easy design using the Motor selection tool

- ▼ **Smart alternative to stepper motors**  
Torque performance comparison for a 100W motor.

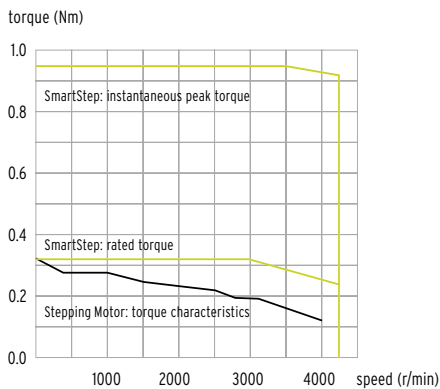

- ▼ **Easy to set up**  
Dip switches on the front panel enable you to program all basic parameter settings, including auto-tuning. The SigmaWin (Wmon) tool software can be used, providing advanced features such as the oscilloscope.



13



- ▲ **SmartStep in labelling machines**  
This labelling machine sticks self-adhesive labels to objects, like boxes or bottles that pass through the machine on a conveyor belt. It is solved using a Smartstep to perform a fast, precise and repetitive move of the labeller axis in order to stick all the labels at the right place.



- ◀ Servo motors for the output range from 0.03 to 0.75 kW.

## EXTRA FLEXIBILITY AND EASY CONNECTIVITY

XtraDrive • Built in intelligence via open fieldbus



If your application demands the highest positional accuracy combined with the shortest cycle times, the most compact size and an ability to connect to a Profibus network then look no further than XtraDrive. As a result of the revolutionary algorithms residing within the drive, XtraDrive offers the tightest control, providing near zero settling time, beneficial in a host of applications such as Point-To-Point control.

Furthermore, the Xtradrive has a simple Auto-tune function, so no expert tuning knowledge is required. As standard in the Xtradrive unit is a controller capable of Point-To-Point, e-cam and master-slave motion control. Virtually any servo motor, including linear versions, can connect to Xtradrive, plus a further version includes Profibus DP connectivity that can be easily configured in a Siemens Step 7 environment. The range is available in power ratings from 30W to 5kW.

**Features XtraDrive**

- Patented non-linear technique for tight position control
- Very low tracking error with no overshoot and zero settling time
- Patented PWM enables highest torque bandwidth
- Integrated positioner with various programmable motion profile modes and intelligent control
- Embedded PROFIBUS available
- Ideal for controlling Omron-Yaskawa linear motors
- 1.5 Axis (Master-Slave with automatic offset correction)
- Oscillation Canceling Algorithm (OCA)

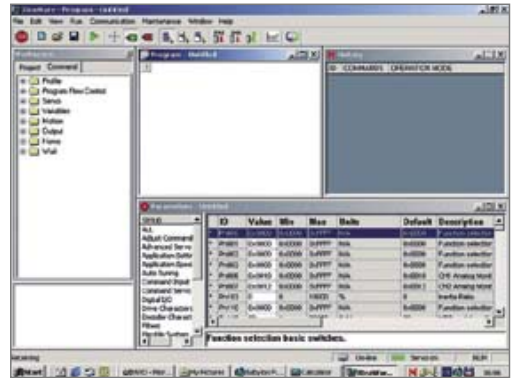

▲ **Xtraware Software**

Xtraware is an advanced software tool for setup, optimal tuning and user programming of the XtraDrive

▼ **NCT**

Non-linear control, adaptive feed-forward algorithm and digital processing of encoder pulses, provide both small tracking error and zero settling time.

- Increased throughput
- Reduced influence of external perturbations



- ▲ XtraDrive-DP provides all the benefits of XtraDrive family while running on PROFIBUS network

XtraDrive Product

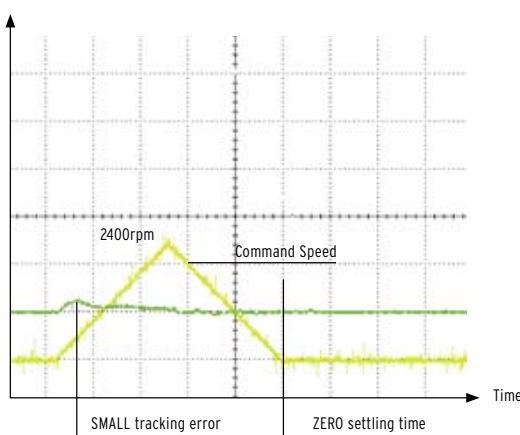

Other Driver

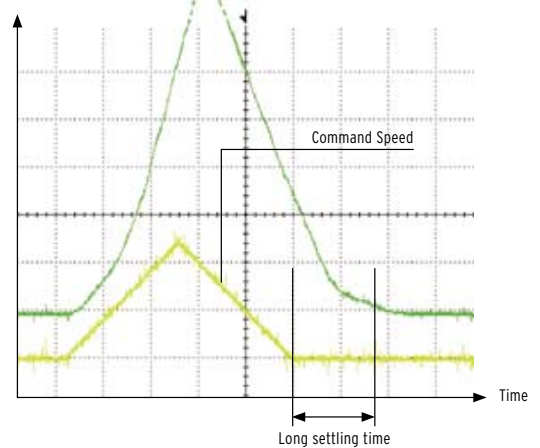

- ▲ **Small tracking error, zero settling time**



## WHEN SPEED MATTERS, LINEAR IS THE ANSWER

### Sigma LM • Making the difference



Driven by ever-increasing demands for higher speed, higher precision, plus quieter and cleaner operations, many industry sectors such as semiconductors, electronic assembly, medical and packaging are increasingly turning to linear motor technology.

They offer unchallenged performance in terms of force thrust and speed. As well as the performance advantages, the Omron-Yaskawa linear drive ranges, thanks to their simplicity

and reliability, are now gaining even wider acceptance in the printing, textile, machine tools and plastics sectors.

We offer as standard the iron core FW series with speeds up to 5.0 m/s and force from 86 to 2400N. On request we can supply the coreless GW type or core-type TW with magnetic attraction cancellation (MAC). The latter is a unique design offering ultra-compact size, high thrust and minimum load on bearings factor.

- Can reach speeds up to 5 meters per second with a resolution of 0.078  $\mu\text{m}$
- Coreless and Iron core types available
- Direct control of the motors using XtraDrive and Sigma-II drives
- Improved machine performance
- Ease of operation & high reliability
- Designed for high force density in compact packages
- Exhibit exceptional Force Linearity even near the peak force regions
- Extremely energy efficient. Due to its optimised magnetic circuitry design and high-density windings

### Coreless TW Type

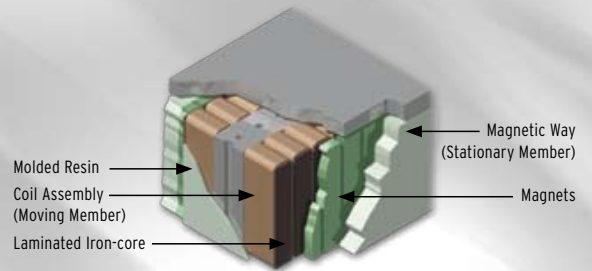

- ▲ Iron-core TW linear motors with magnetic attraction cancellation

### Iron Core GW Type

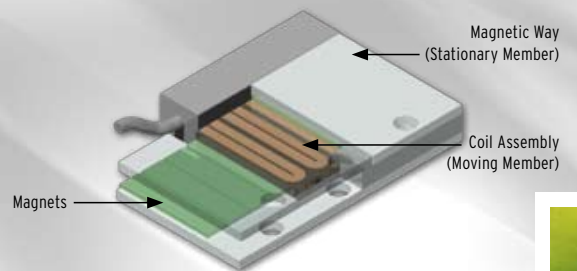

- ▲ Coreless GW linear motors construction results in zero-attraction force and zero-cogging
- ▼ Magnetic attraction force between the moving and the stationary parts can be used to increase the rigidity of the system by pre-loading the linear motor bearings

- ▼ The coil assembly of the FW linear motors are composed of laminated iron-core and pre-wound coil bobbins inserted into the slots located on the laminated iron-cores. The entire coil unit, after the precision assembly process, is permanently encapsulated in a thermally conductive resin body to give structural rigidity.

The magnetic way of the FW is made from a row of rare-earth magnets accurately placed on one side of the nickelized steel carrier plate.

Stainless-steel magnet covers against minor accidental damages protect the magnets on the FW magnetic ways.

### Construction

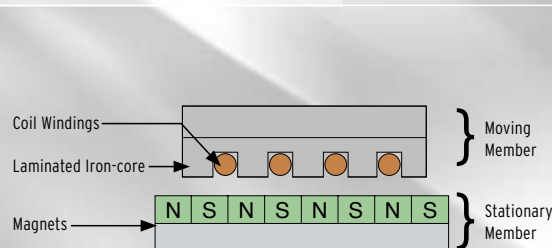

### Iron Core FW Type

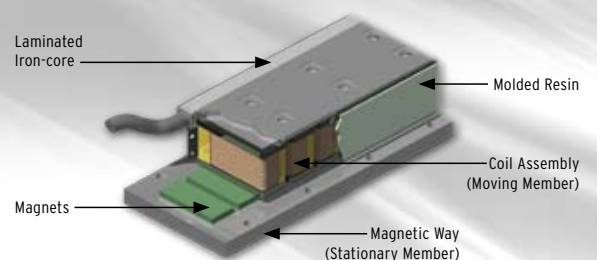

## SMALL, SIMPLE AND SMART

### Varispeed J7 • Simplicity



Simplicity and cost effectiveness are the key design features for the J7. Using Volts/Frequency control with on-line torque compensation the drive provides 100% torque down to 1.5Hz. The J7 has a built-in speed setting potentiometer, 4 configurable inputs, one configurable relay output as well as a multi-function analogue output.

The J7 can drive motor sizes from 0.1 to 4kW. By adding an interface card it can be configured via a PC with Sysdrive configurator, a package allowing off-line parameter set-up, ideal for setting multiple drives. On request the J7 can communicate with popular fieldbuses.

Features J7

- Power range 0.1-4kW
- V/f control
- Compact size
- Frequency setting signal 0-10V / 4-20mA
- 150% overload / 60sec.
- 100% torque at 1.5Hz
- Overload detection
- Motor thermal protection
- Freely configurable V/f curve
- DC injection braking
- 8 configurable fixed frequencies
- 4 programmable digital inputs
- 1 programmable relay output
- 1 programmable analogue output
- Optional RS232/485
- PC configuration tool Sysdrive Configurator

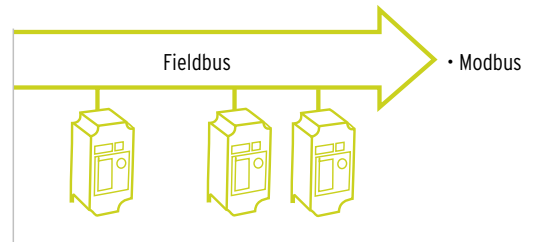

▲ ▼ 6-track folding machine for large laundry facilities: frequency inverter J7 allows variable speeds on the different track.



▼ Block diagram for frequency inverter J7.

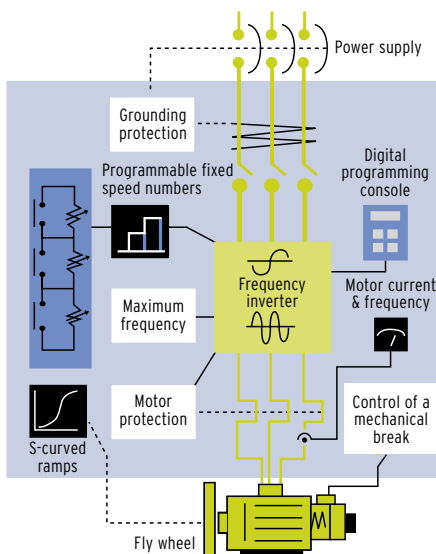

▼ Inverter J7 controls the speed and positioning of a car wash station



# SENSORLESS FLUX VECTOR IN A POCKET SIZED INVERTER

3G3MV • Designed for your needs



PLC Option • Intelligence into the inverter

## The 3G3MV series

For such a small sized drive, the 3G3MV offers all the functionality you'll need. Sensorless vector control ensures 100% torque down to 0.5 Hz, full motor protection is standard, and interfaces to the popular fieldbuses are available. In addition, a PLC option unit turns the 3G3MV into the most complete and versatile drive on the market today.

The 3G3MV accepts analogue and pulse input, hence simplifying the interface for simple positioning control. The 3G3MV range includes sizes from 0.1 to 7.5kW with built-in dynamic brake.

## The PCD / PLC option

Based on established Omron PLC technology, the PCD option offers all the advantages of an Omron PLC for the 3G3MV inverter. It comes as standard with a high speed counter, Real Time Clock, 4kWord memory and 10 I/O, and is programmed with CX Programmer.

This ultra-compact configuration is ideal for applications where compact system size and quick development are essential such as automatic door control, small scale hoists, indexing tables, modular conveyor systems, etc.





**Features 3G3MV**

- Power range 0.1-7.5 kW
- Sensorless vector controlled inverter
- Compact size
- Frequency setting signal 0-10V/4 -20mA
- 150% overload/60 sec
- 100% torque at 0.5 Hz
- Customised application firmwares
- Overload detection
- Pulse input for speed reference
- Programmable second analogue input integrated PID controller
- 16 programmable fixed frequencies
- DC injection braking
- Built-in operator/copy unit
- PC configuration tool Sysdrive Configurator

**Features PLC Option Unit**

- Fully featured Omron PLC embedded into the inverter
- Direct connection to MV Inverter via Dual Port Ram
- Complete control of inverter parameters
- Encoder Input, Interrupt inputs and Pulse outputs
- Real time clock and calendar available
- Control of inverter hardware (analog input, digital I/O)
- Mechatronics functions (Counter, PID, filter, etc.)
- Single point programming
- Programmed using the standard Omron PLC software
- RS-422/485 serial port available

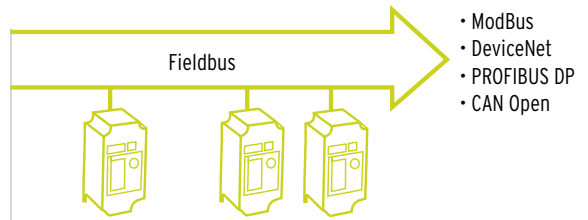

▲ **Pump sequencer**

The MV inverter and the PLC option unit provide a continuous closed loop control of the first pump, plus ON/OFF control on the others.



▲ **Powder coating system**

The 3G3MV frequency inverter is connected to the PLC via the ModBus field bus. In this way, various conveyor circuits can be monitored and synchronised.

## DRIVE YOUR ENERGY COST DOWN

### Varispeed E7 • Designed for pumps and fans



The E7 series is designed to be the ultimate inverter for driving your energy cost down. An energy saving algorithm, an IP54 housing, a PID loop and a 12 pulse converter are part of the E7 standard features. The energy saving algorithm allows up to 20% energy saving against conventional Volts/Frequency control through near perfect auto-adaptive control of motor flux and load.

The 12 pulse converter is available on units from the 22 kW model and above, significantly reducing harmonic distortion, hence eliminating the need for external AC reactors in most applications. The E7 is available in sizes from 0.4 up to 300 kW as standard and up to 800 kW on request.

Features E7

- Power range 0.4-300kW
- V/f controlled frequency inverter
- Frequency setting signal 0-10V/4-20mA
- Silent operation
- Energy saving function
- Integrated PID controller with sleep function
- Programmable second analogue input
- 12 pulse operation (22kW and above)
- Built-in DC reactor (22kW and above)
- DC injection braking
- Rotating motor pick up
- Customised application firmwares
- PC configuration tool Sysdrive Configurator
- PLC Option Unit. Same unit used with Varispeed F7
- IP54 Enclosure available

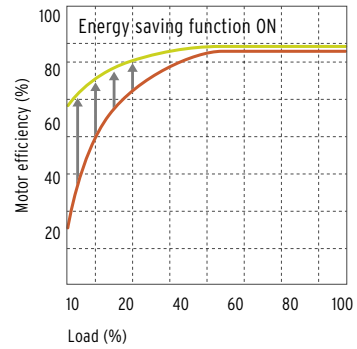
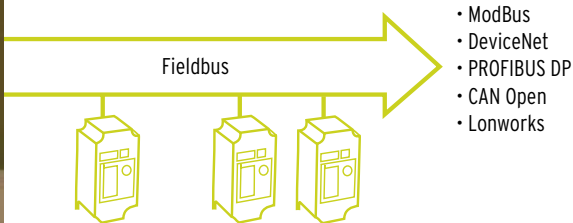

▲ ▼ Energy-saving function and improved power factor lower energy costs.

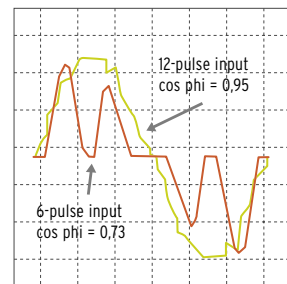

▲ Liquid handling: fan and pump drives.



# TOWARDS SERVO PERFORMANCE FROM AC MOTORS

## Varispeed F7 · A new generation of flux vector drives



## PLC Option · Intelligence into the inverter

Building on the phenomenal success of the previous 3G3RV model, Omron-Yaskawa have improved upon the flexibility and functionality to produce a drive for today's market. Examples include a non-rotating auto-tune function, a comprehensive LCD display, customisable software (CASE) and a host of features that make the F7 one of the easiest and most versatile flux vector drives.

Option cards are available to connect to Mechatrolink, Profibus, DeviceNet and CAN networks. The F7, as with the V7, can host a true PLC option board. The power range of the F7 is from 0.4 up to 300 kW as standard and up to 800 kW on request. The F7 is ideal for all heavy duty, high precision torque and speed control applications.

### The PCD / PLC option

Based on established Omron PLC hardware technology, the PCD option offers all of the features of the V7 option, and in addition provides the possibility to have DeviceNet slave connectivity and CompoBus-S master capability. This means that the F7 can sit within the Omron automation platform, and have expandable I/O through CompoBus-S I/O units. This configuration is ideal for hoists, cranes and palletiser systems.

## Features F7

- Power range 0.4-300kW
- Open and Closed loop flux vector control
- Silent operation
- 200% starting torque
- Rotating and Non-Rotating auto-tuning modes
- Customised application firmware
- Intelligent dynamic braking
- Integrated PID controller with sleep function
- Pulse input and output, for speed reference
- 12 pulse operation (22 kW and above)
- Inbuilt DC reactor (22 kW and above)
- Position synchronisation via optional card
- PC configuration tool Sysdrive Configurator

## Features of PLC-Option

- Fully featured Omron PLC embedded into the inverter
- PLC Board directly connected in to the Inverter
- Complete control of inverter parameters
- Encoder Input, Interrupt inputs and Pulse outputs
- Real time clock and calendar
- Control of inverter hardware (analog input, digital I/O)
- Mechatronics functions (Counter, PID, filter, etc.)
- Single point programming
- Programmed using the standard Omron PLC software
- RS-232 serial port
- RS-422/485 serial port
- CompoBus/S master capability
- DeviceNet available

- ▼ Auto-tuning at zero speed and excellent low-speed torque characteristics ensure easy start-up and optimal running behaviour.

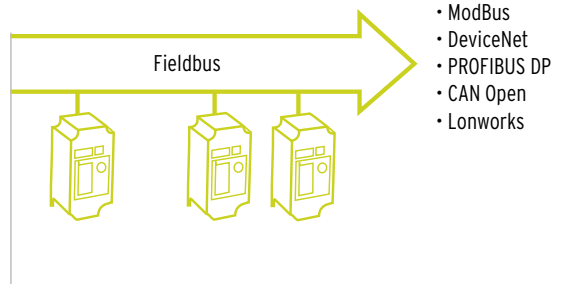

- ▲ High starting torque and stable torque performance even at low speeds are particularly important in mixer and extruder applications.

- ▼ Over 200% torque even at low speeds.

25

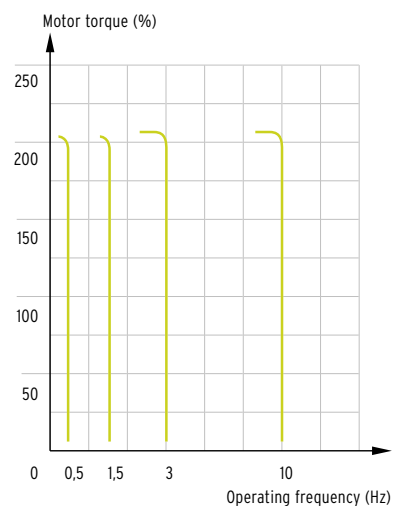

## STOP THE SEARCH, ENJOY THE RIDE



### Varispeed L7 · Made to drive lifts

The Varispeed L7 is based on years of experience in inverter design, and uses the latest proven technology to provide reliability and safety. Furthermore, lift-specific features have been developed in response to market needs.

These standard features include direct control of motor brake and motor contactor, short floor operation, door opening control and hardware base block. In addition, both open loop and closed loop vector control is available in the Varispeed L7, providing the optimum speed regulation to suit the application.

Ease of use has been considered from the outset. An LCD operator is available to provide plain text set-up and monitoring of the inverter, while a non-rotating auto-tuning function ensures the inverter can obtain all of the required motor information without the need to decouple the motor from the gearbox. Option cards are available to integrate the L7 series into communication networks such as CANopen, DeviceNet or Profibus-DP.

## Features L7

- High rated output current
- Direct control of motor brake and contactor
- Dedicated Lift sequence
- Emergency evacuation (battery operation)
- Short floor operation
- Door opening control
- Auto-tuning at standstill
- Connectivity to all popular fieldbuses
- PC configuration and commissioning tool
- PLC Option Unit. Same unit used with Varispeed F7

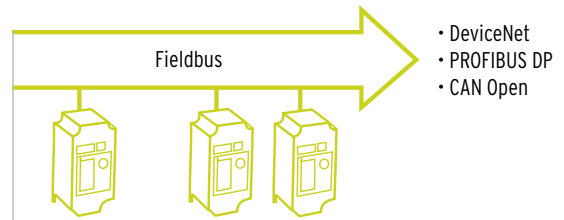

### ▼ High reliability

Omron-Yaskawa's frequency inverters are currently being used in over 100,000 lifts around the world! The L7 ensures 3 million full load starts during its lifetime.



27

- ▶ Designed specifically for the lift market, the L7 series ensures that lifts exceed the ride quality and safety demands of the market.

Available in power ratings from 3.7 kW up to 55 kW, the Varispeed L7 offers a cost-effective solution for all your lift requirements.



# COMPLETE OVERVIEW OF THE OMRON MOTION AND DRIVES RANGE

Servo Drives			
Type	Sigma-II Series	SmartStep	XtraDrive
Output Range	0,03 - 55 KW	30W - 750 W	30W- 3kW
Rated Torque	0,095 - 350 Nm	0,095 - 2,39 Nm	0,095-18,6 Nm
Peak Torque	0,296 - 700 Nm	0,286 - 7,1 Nm	0,286 - 45,1 Nm
1 x 230 V	Yes	Yes	Yes
3 x 230 V	Yes	No	Yes
3 x 400 V	Yes	No	Yes
Speed Regulation	Analogue $\pm 10V$	No	Analogue $\pm 10V$
Torque Regulation	Analogue $\pm 10V$	No	Analogue $\pm 10V$
Positioning	Pulse Train Input	Pulse Train Input	Pulse Train Input
Torque Loop Cycle	62,5 MicroSec	62,5 MicroSec	62,5 MicroSec
Motors 1000 rpm	Yes	No	Yes
Motors 1500 rpm	Yes	No	Yes
Motors 2000 rpm	Yes	No	Yes
Motors 3000 rpm	Yes	Yes	Yes
Motors 6000 rpm	Yes	No	Yes
Encoder Resolution	max. 17 bit	2000 ppr x 4	max. 17 bit
Serial Interfaces	RS-232C / 422 DeviceNet Profibus DP Mechatrolink II	RS-232C / 422	RS-232C / 422 DeviceNet Profibus DP

Motion Controllers				
Type	MCH	MC402	MCW151	CJ1W-NC
Total No. of Axes	32	8	3	1 to 4
No. of Real Axes	30	4	1	1 to 4
Type of controller	PLC Based	PLC Based	Servo Based	PLC Based
Programming	Basic Type Language			Ladder
Servo Control	Mechatrolink II	Analogue $\pm 10V$	Direct Connection	Pulse Train Input
Cycle time	0,5 to 8 ms	1 ms	0,5 to 1 ms	N/A
Memory Size	2 MB	128 KB	128 KB	N/A
Hardware Registration	1 per axis	1 per axis	3	N/A
Point-to-Point Moves	Yes	Yes	Yes	Yes
Interpolated Moves	Yes	Yes	Yes	Yes
Axes Synchronisation	Yes	Yes	Yes	No
Electronic CAMs	Yes	Yes	Yes	No
Serial Interfaces	PLC Based Mechatrolink II	PLC Based	RS-232C/485/422  HostLink  DeviceNet	PLC Based

Frequency Inverters					
Type	J7	3G3MV	E7	F7	L7
Output range	0.1 - 4.0 kW	0.1 - 7.5 kW	0.4 - 300 kW	0.4 - 300 kW	4 - 55 kW
1 x 230 V	Yes	Yes	No	No	No
3 x 230 V	Yes	Yes	Yes	Yes	Yes
3 x 400 V	Yes	Yes	Yes	Yes	Yes
Regulation process	V/f	V/f	V/f	V/f	V/f
		Sensorless flux vector		Sensorless flux vector	Sensorless flux vector
				Closed loop flux vector	Closed loop flux vector
Digital inputs	5	7	7	7	8
Digital outputs	1	3	3	4	4
Analogue inputs	1	2	2	2	1
Analogue outputs	1	1	2	2	No
Pulse input	No	Yes	No	Yes	No
Pulse output	No	Yes	No	Yes	No
Int. braking transistor	No	Yes	To 18.5 kW	To 18.5 kW	To 18.5 kW
Ser. interfaces	ModBus	ModBus, DeviceNet, Profibus DP CAN Open	ModBus, DeviceNet, Profibus DP, CAN Open Lonworks	ModBus, DeviceNet, Profibus DP , CAN Open Lonworks	DeviceNet, Profibus DP CAN Open

# PRODUCT SELECTION TABLE



## Motion Controllers

### PLC based Controllers

#### Position Control Units

- CJ1-NCs
- CS1-NCs

#### Motion Control Units

- CS1-MCs
- C200HW-MC402
- CS1W-MCH

### Servo based Controllers

- DeviceNet Unit NS300
- Profibus-DP Unit NS500
- Indexer Unit NS600
- 1.5 Axis Motion MCW151



## Servo Systems

- SmartStep Series
- Sigma-II Series
- Sigma-II Large Capacity
- Sigma Linear Motors
- XtraDrive



## Frequency Inverters

- Varispeed J7
- Sysdrive 3G3MV
- Varispeed E7
- Varispeed L7
- Varispeed F7

### PLCs in the Inverter:

- 3G3MV Inverter PLC
- F7/L7/E7 Inverter PLC

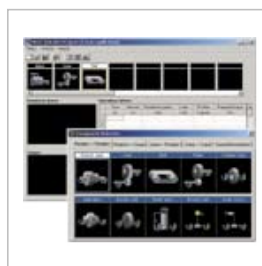

## Software

- CX-Position
- CX-Motion
- Motion Perfect
- MCH Tool
- XtraWare
- SigmaWin+
- Sysdrive Configurator

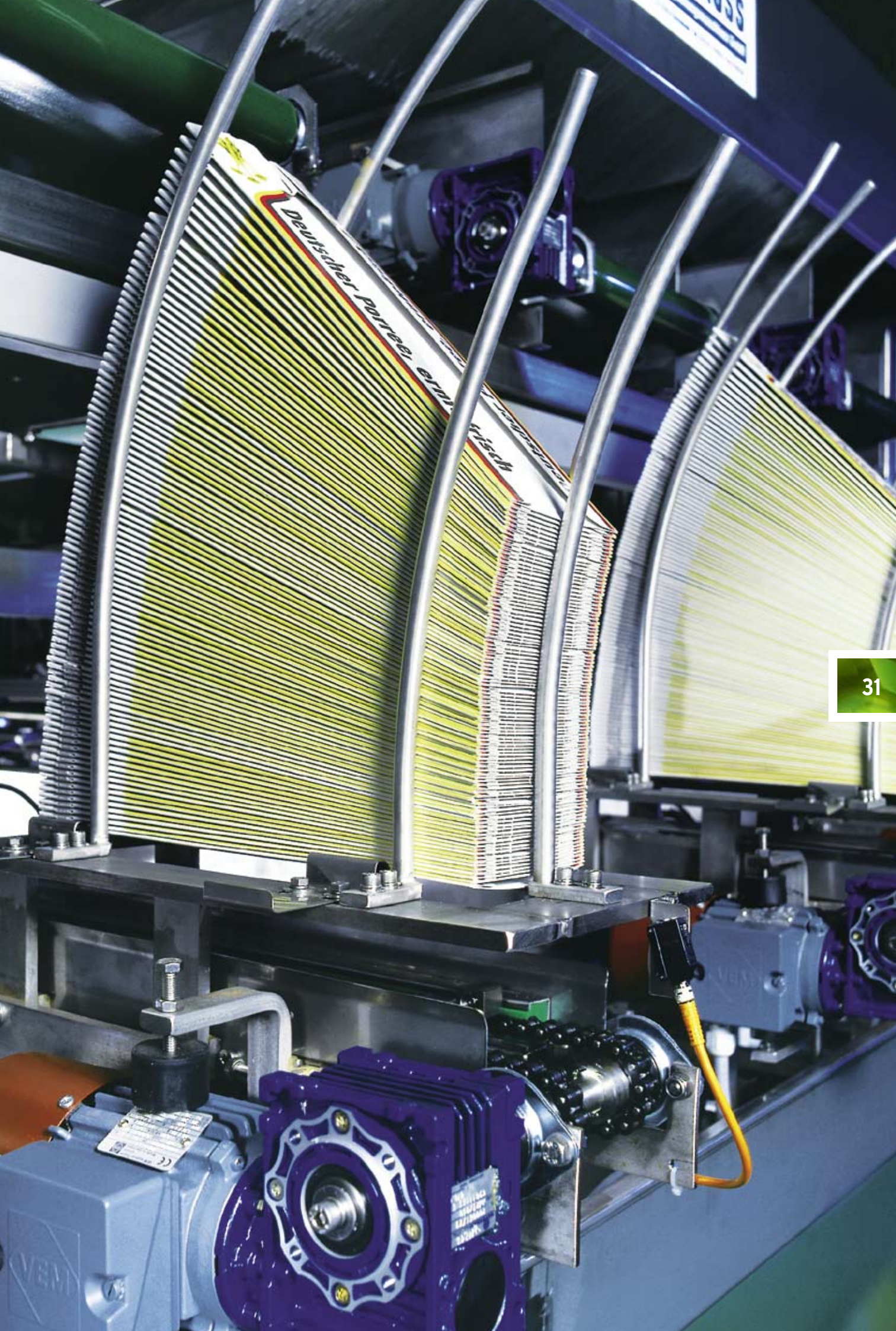



# Main Content

**Motion Control 35**

PLC based Controllers		
Position Control Units	CJ1-NCs	37
	CS1-NCs	39
Motion Control Units	CS1-MCs	41
	C200HW-MC402-E	43
	CS1W-MCH71	45
Servo based Controllers		
DeviceNet Unit	JUSP-NS300	51
PROFIBUS-DP Unit	JUSP-NS500	57
Indexer Unit	JUSP-NS600	63
1.5 Axis Motion Controller	R88A-MCW151	69

**AC Servo Systems 75**

SmartStep Series	77
Sigma-II Series	95
Sigma-II Large Capacity	129
Sigma Linear Motors	143
XtraDrive	169

**Frequency Inverters 191**

Varispeed J7	193	
SYSDRIVE 3G3MV	205	
Varispeed E7	219	
Varispeed L7	237	
Varispeed F7	253	
Inverter PLCs	3G3MV Inverter PLC	271
	F7/L7/E7 Inverter PLC	279

**Software 287**

CX-Position	289
CX-Motion	291
MCH-Tool	293
Motion Perfect	295
SigmaWin+	297
XtraWare	299
SYSDRIVE Configurator	301

**Technical Information 303**

**Technical Documentation 307**

**Contact Information 309**

**Index 327**

Motion Control

AC Servo Systems

Frequency Inverters

Software

Technical Information

Technical Documentation

Contact Information

Index



# Technical Information

## Mechatronics formulae

### Linear movement

Symbol	Description	Units
<b>s</b>	Space	m
<b>v</b>	Velocity	m/s
<b>a</b>	Acceleration	m/s <sup>2</sup>
<b>F</b>	Force	N
<b>P</b>	Power	W
<b>W</b>	Energy	J
<b>t</b>	Time	s
<b>μ</b>	Friction coefficient	--
<b>g</b>	Gravity acceleration	m/s <sup>2</sup>
<b>m</b>	Mass	Kg

Speed (m/s)

$$v = \frac{\partial s}{\partial t}$$

Acceleration (m/s<sup>2</sup>)

$$a = \frac{\partial v}{\partial t}$$

Acceleration force (N)

$$F_a = m \cdot a$$

Force friction (N)

$$F_\mu = \mu \cdot m \cdot g \cdot \cos\beta$$

Force gravity (N)

$$F_g = m \cdot g \cdot \sin\beta$$



Force root means square (N)

$$F_{rms} = \sqrt{\frac{\sum_i t_i \cdot F_i^2}{\sum_i t_i}}$$

Power (W)

$$P = F \cdot v$$

Cynetic energy

$$W = \frac{1}{2} \cdot m \cdot v^2$$

### Rotary movement

Symbol	Description	Units
<b>Φ</b>	Angle	rad
<b>ω</b>	Angular velocity	rad/s
<b>α</b>	Angular acceleration	rad/s <sup>2</sup>
<b>T</b>	Torque	Nm
<b>P</b>	Power	W
<b>W</b>	Energy	J
<b>t</b>	Time	s
<b>i</b>	Gear reduction	--
<b>r</b>	Radius	m
<b>J</b>	Inertia	Kgm <sup>2</sup>

Speed (rad/s)

$$\omega = \frac{\partial \phi}{\partial t}$$

Acceleration (rad/s<sup>2</sup>)

$$\alpha = \frac{\partial \omega}{\partial t}$$

Acceleration torque (Nm)

$$T_\alpha = J \cdot \alpha$$

Torque root means square (Nm)

$$T_{rms} = \sqrt{\frac{\sum_i t_i \cdot T_i^2}{\sum_i t_i}}$$

Power (W)

$$P = T \cdot \omega$$

Cynetic energy

$$W = \frac{1}{2} \cdot J \cdot \omega^2$$

Example in case of trapezoidal profile (linear):

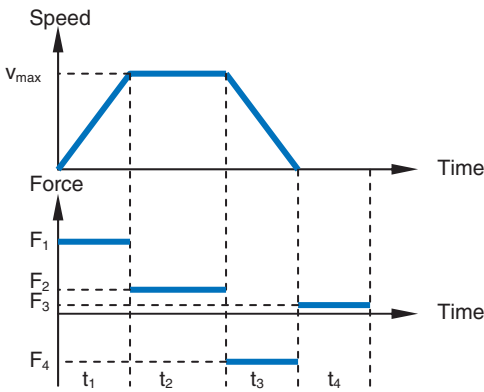

1. Acceleration

$$a = \frac{v_{max}}{t_1}$$

$$s_1 = \frac{1}{2} \cdot v_{max} \cdot t_1$$

$$F_a = m \cdot a$$

$$F_{1\_Total} = F_a + F_{\mu} + F_{ext}$$

2. Constant speed

$$a = 0$$

$$s_2 = v_{max} \cdot t_2$$

$$F_{2\_Total} = F_{\mu} + F_{ext}$$

3. Deceleration

$$d = \frac{v_{max}}{t_3}$$

$$s_3 = \frac{1}{2} \cdot v_{max} \cdot t_3$$

$$F_d = m \cdot d$$

$$F_{3\_Total} = F_{\mu} + F_{ext} - F_d$$

4. Dwell

$$s_4 = 0$$

$$F_{4\_Total} = F_{ext}$$

Force rms:

$$F_{rms} = \sqrt{\frac{t_1 \cdot F_1^2 + t_2 \cdot F_2^2 + t_3 \cdot F_3^2 + t_4 \cdot F_4^2}{t_1 + t_2 + t_3 + t_4}}$$

Example in case of trapezoidal profile (rotary):

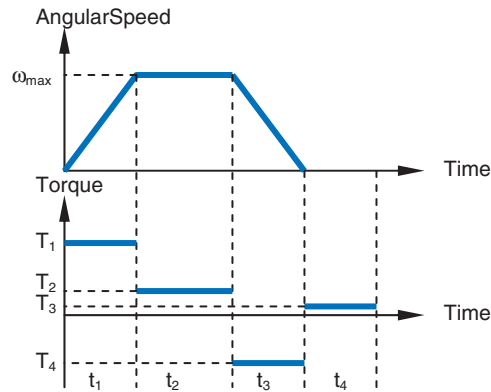

1. Angular acceleration

$$\alpha = \frac{\omega_{max}}{t_1}$$

$$\phi_1 = \frac{1}{2} \cdot \omega_{max} \cdot t_1$$

$$T_{\alpha} = J \cdot \alpha$$

$$T_{1\_Total} = T_{\alpha} + T_{\mu} + T_{ext}$$

2. Constant speed

$$\alpha = 0$$

$$\phi_2 = \omega_{max} \cdot t_2$$

$$T_{2\_Total} = T_{\mu} + T_{ext}$$

3. Deceleration

$$\gamma = \frac{\omega_{max}}{t_3}$$

$$\phi_3 = \frac{1}{2} \cdot \omega_{max} \cdot t_3$$

$$T_{\gamma} = J \cdot \gamma$$

$$T_{3\_Total} = T_{\mu} + T_{ext} - T_d$$

4. Dwell

$$\phi_4 = 0$$

$$T_{4\_Total} = T_{ext}$$

Torque rms:

$$T_{rms} = \sqrt{\frac{t_1 \cdot T_1^2 + t_2 \cdot T_2^2 + t_3 \cdot T_3^2 + t_4 \cdot T_4^2}{t_1 + t_2 + t_3 + t_4}}$$

For linear motors you have just to apply the formulae for linear motors considering the mass of the load plus the mass of the motor. For rotary motors it is necessary to apply some cinematic transformations to have the magnitudes **from the motor side**.

Case of rotary table:

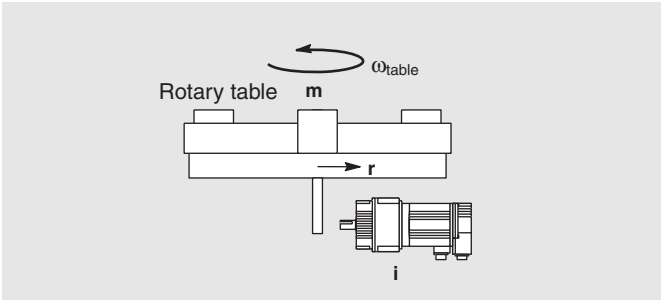

$$J_{total} = J_{motor} + \frac{\frac{1}{2} \cdot m \cdot r^2}{i^2}$$

$$\omega_{motor} = \omega_{table} \cdot i$$

$$T_{motor\_side} = J_{total} \cdot \alpha_{motor\_side}$$

Case of a belt drive with two pulleys:

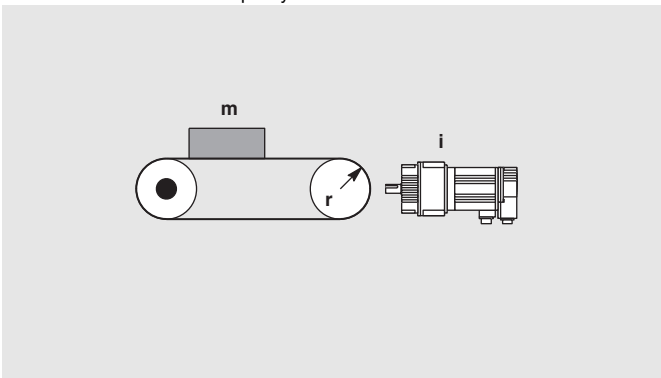

$$J_{total} = J_{motor} + \frac{2 \cdot J_{pulley} + J_{load}}{i^2}$$

$$J_{total} = J_{motor} + \frac{2 \cdot \frac{1}{2} \cdot m_{pulley} \cdot r^2 + m_{load} \cdot r^2}{i^2}$$

$$\alpha_{motor\_side} = a \cdot \frac{2\pi}{r} \cdot i$$

$$T_{motor\_side} = J_{total} \cdot \alpha_{motor\_side} + \frac{m \cdot \mu \cdot g \cdot r}{i}$$

Case of an hanging load:

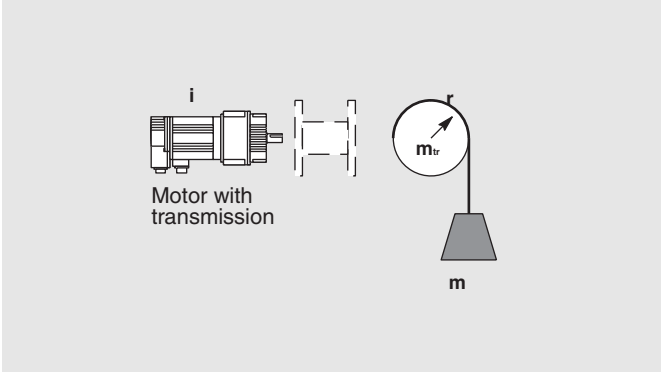

$$J_{total} = J_{motor} + \frac{2 \cdot J_{reel} + J_{load}}{i^2}$$

$$J_{total} = J_{motor} + \frac{\frac{1}{2} \cdot m_{reel} \cdot r^2 + m_{load} \cdot r^2}{i^2}$$

$$\alpha_{motor\_side} = a \cdot \frac{2\pi}{r} \cdot i$$

$$T_{motor\_side} = J_{total} \cdot \alpha_{motor\_side} \pm \frac{m \cdot g \cdot r}{i}$$

Note: The sign (±) depends on the direction of the movement

Case of a ballscrew:

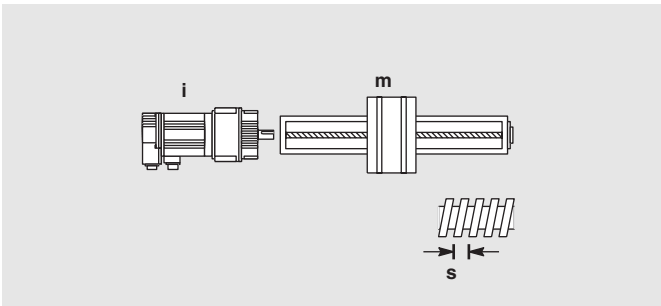

$$J_{total} = J_{motor} + \frac{\left(\frac{s}{2\pi}\right)^2 \cdot m + \frac{1}{2} \cdot m_{screw} \cdot r_{screw}^2}{i^2}$$

$$\alpha_{motor\_side} = a \cdot \frac{2\pi}{s} \cdot i$$

$$T_{motor\_side} = J_{total} \cdot \alpha_{motor\_side} + \frac{m \cdot \mu \cdot g \cdot \frac{s}{2\pi}}{i}$$

## Motor selection

### Linear motor

The selected linear motor must match the next conditions.

$$v_{\max\_motor} > v_{\max\_application}$$

$$F_{\max\_motor} > \frac{F_{\text{peak\_application}}}{\eta}$$

$$F_{\text{rated\_motor}} > \frac{F_{\text{rms}}}{\eta}$$

Where:  $\eta$ =Mechanical efficiency

**Note 1:** To calculate  $F_{\text{peak\_application}}$  and  $F_{\text{rms}}$  it is necessary to consider the motor mass. This may deal to do some iteration to get the right motor.

**2:** At high speed the motor reduces its rated and maximum force. This may be taken into consideration for high speed application.

**3:** For linear motors it is important to calculate the surface temperature of the motor in addition to the above calculation.

### Rotary motor

The selected linear motor must match the next conditions:

$$\omega_{\max\_motor} > \omega_{\max\_application}$$

$$T_{\max\_motor} > \frac{T_{\text{peak\_application}}}{\eta}$$

$$T_{\text{rated\_motor}} > \frac{T_{\text{rms}}}{\eta}$$

Where:  $\eta$ =Mechanical efficiency

**Note 1:** To calculate  $T_{\text{peak\_application}}$  and  $T_{\text{rms}}$  it is necessary to consider the motor inertia. This may deal to do some iteration to get the right motor.

**2:** Above rated speed the motor reduces its rated and maximum torque. This may be taken into consideration for high speed application. Refer to the Speed-Torque curves of the motor for details.