

E5CSV temperature controller

Ready, set, go!



- » Perfect control
- » Easy setting up
- » Enhanced functionality

Advanced Industrial Automation

OMRON

Perfect temperature control in 4 simple steps



The E5CSV temperature-controller series is the enhanced successor to our E5CS series, the most widely sold temperature-controller that has established itself throughout the world as the ideal choice for simple, cost-effective temperature control.

Keeping the best...

The new series shares many of the outstanding features that made its predecessor such a success – including easy setting-up using DIP and rotary switches, a large 7-segment LED display and choice of ON/OFF or PID control with Self-Tuning. What's more, it still provides an indication of output and alarm status and direction of deviation from set point.

1 Select

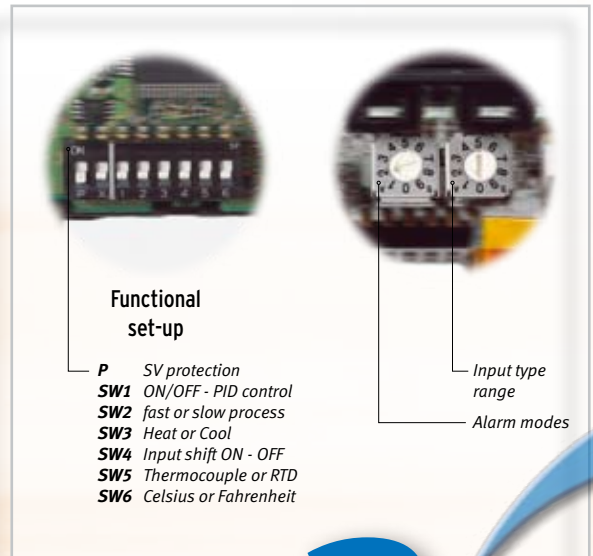

100-240 VAC		24 VAC/VDC	
Relay output	Voltage (pulse) output	Relay output	Voltage (pulse) output

2 Set-up

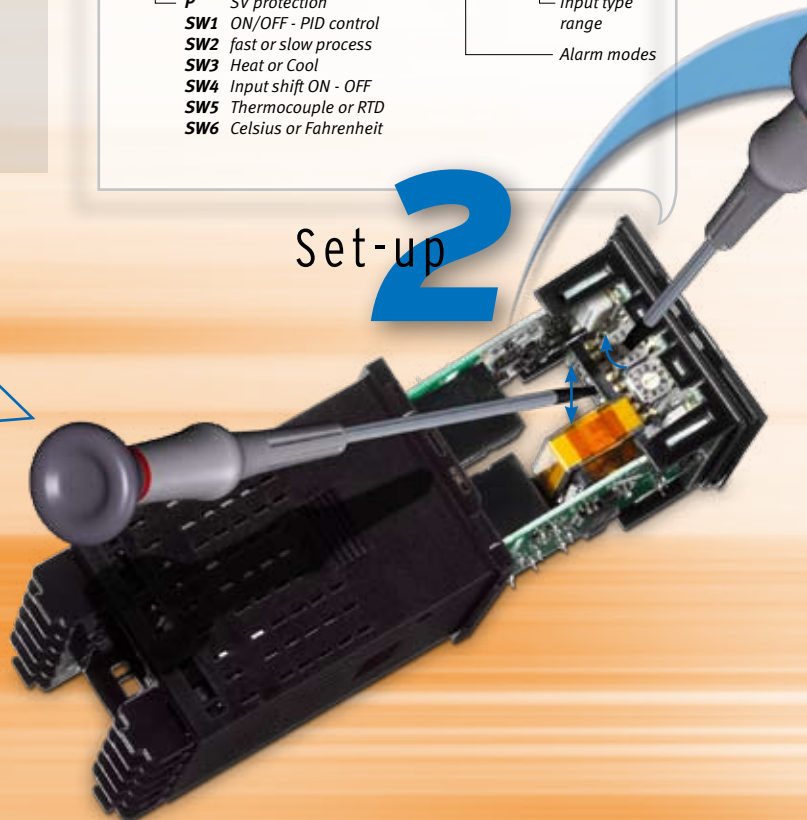

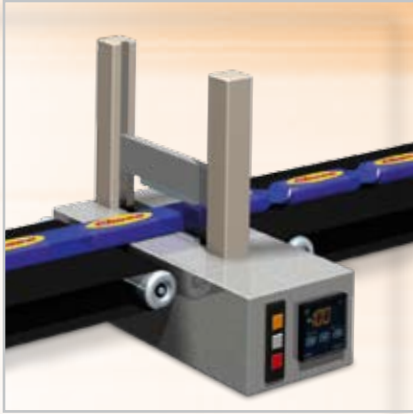

Packing

Excellent control, especially in this disturbance-sensitive application.



Frying

The flat front makes the use of the E5CSV hygienic and it's easy and safe to clean thanks to its IP66 rating.



Sealing

Clear indication that the correct temperature has been reached thanks to the deviation indicator.

Enhancing the rest...

Building on the success of the previous E5CS, however, the new E5CSV series offers much more. Like an Auto-Tune function and the fact that as standard you can now select multiple input types (thermocouple/RTD). A new 3.5 digit display also means that E5CSV can show a larger range, now extending up to 1999 °C. The series also meets new RoHS requirements and complies with the stringent IP66 standard. What's more, depth has been reduced to a mere 78 mm.

Benefits of E5CSV temperature controllers:

- Easy setting-up using DIP and rotary switches
- Meets broad range of basic temperature-control requirements with only 4 models
- No expert knowledge needed to optimise performance because of Self- and Auto-Tuning functions
- Reduced chance of malfunction thanks to set-value protection
- End-user friendly since the menu only has 3 parameters
- Excellent legibility with a large (13.5 mm) single-line, 3.5 digit, 7 segment LED display
- Clear status overview thanks to PV-SV deviation indicator, output and alarm indicator
- Easy connection to a broad range of temperature-sensor types



Mount

3

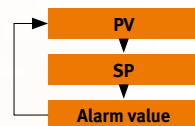

Adjust

4

>> Ready...

>> Set...

>> Go!



Temperature Controllers E5CSV

Easy Setting Using DIP Switch and Simple Functions in DIN 48 x 48 mm-size Temperature Controllers

- Easy setting using DIP and rotary switches.
- Multi-input (thermocouple/platinum resistance thermometer).
- Clearly visible digital display with character height of 13.5 mm.
- RoHS compliant.



NEW

Model Number Structure

Model Number Legend

Models with Terminal Blocks

E5CSV- 1T -500
1 2 3 4 5

- | | | |
|--|--|---|
| <p>1. Output type
 R: Relay
 Q: Voltage for driving SSR</p> <p>2. Number of alarms
 1: 1 alarm</p> | <p>3. Input type
 T: Thermocouple/platinum resistance thermometer (multi-input)</p> | <p>4. Power supply voltage
 Blank: 100 to 240 VAC
 D: 24 VAC/VDC</p> <p>5. Terminal cover
 500: Finger protection cover</p> |
|--|--|---|

Ordering Information

List of Models

Size	Power supply voltage	Number of alarm points	Control output	TC/Pt multi-input Incl. terminal cover
1/16 DIN 48 x 48 x 78 mm (W x H x D)	100 to 240 VAC	1	Relay	E5CSV-R1T-500
			Voltage (for driving SSR)	E5CSV-Q1T-500
	24 VAC/VDC	1	Relay	E5CSV-R1TD-500
			Voltage (for driving SSR)	E5CSV-Q1TD-500

Accessories (Order Separately)

Protective Front Cover

Type	Model
Hard Protective Cover	Y92A-48B

Installation

- All models in the E5CSV Series conform to DIN 43700 standards.
- The recommended panel thickness is 1 to 4 mm.
- Be sure to mount the E5CSV horizontally.

Mounting the E5CSV

1. For waterproof mounting, waterproof packing must be installed on the Controller. Waterproofing is not possible when group mounting several Controllers.
2. Insert the E5CSV into the mounting hole in the panel.
3. Push the adapter from the terminals up to the panel, and temporarily fasten the E5CSV.
4. Tighten the two fastening screws on the adapter. Alternately tighten the two screws little by little to maintain a balance. Tighten the screws to a torque of 0.29 to 0.39 N-m.

Dimensions

Note: All units are in millimeters unless otherwise indicated.

Controller

E5CSV

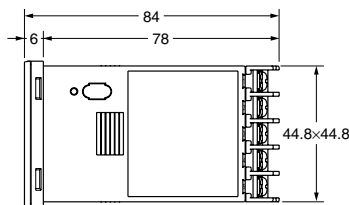
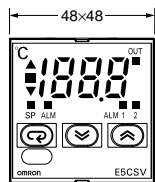
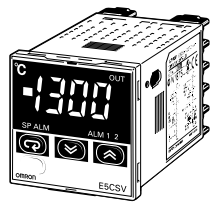

Panel Cutout Dimensions

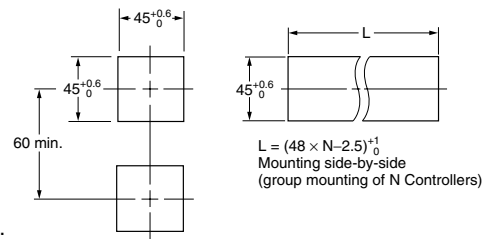

Note: Terminals cannot be removed.

Hard Protective Cover



The Y92A-48B Protective Cover (hard type) is available for the following applications.

- To protect the set from dust and dirt.
- To prevent the panel from being accidentally touched causing displacement of set values.
- To provide effective protection against water droplets.

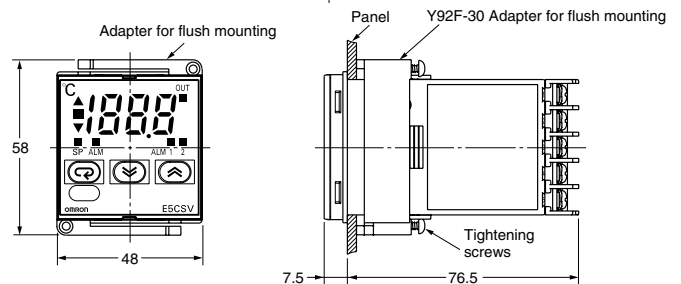

- Note:**
1. The recommended panel thickness is 1 to 4 mm.
 2. Group mounting is possible in one direction only.

Terminal Cover

E53-COV10

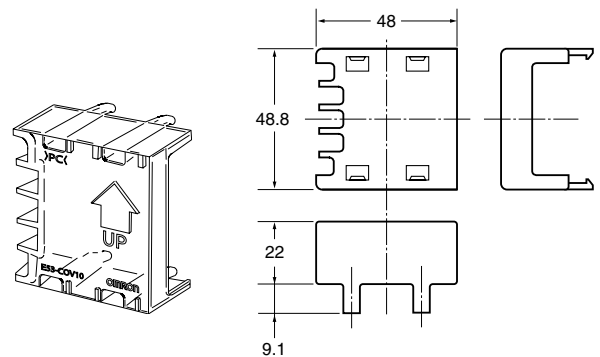
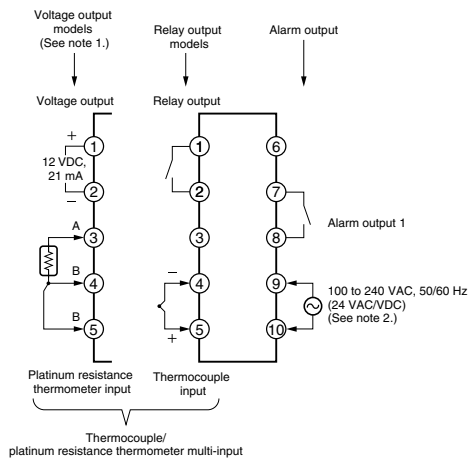

- Note:**
1. The voltage output (12 VDC, 21 mA) is not electrically isolated from the internal circuits. When using a grounding thermocouple, do not connect output terminals 1 or 2 to ground. Otherwise, unwanted current paths will cause measurement errors.
 2. Models with 100 to 240 VAC and 24 VAC/VDC are separate. Models using 24 VDC have no polarity.

Operation

E5CSV

Deviation indicators

The Δ indicator lights when the PV is greater than the SP and the ∇ indicator lights when the PV is less than the SP. The \square indicator (green) lights when the deviation is less than 1% FS (0.25% FS for multi-input models). These indicators flash during ST (self-tuning)/AT (auto-tuning).

Mode indicators

The SP indicator lights when the setting temperature is being displayed. The ALM indicator lights when the alarm value 1 is being displayed.

Mode Key

When the power is turned ON, normally the display will use the display items in the following order each time the Mode Key is pressed.

```

graph TD
    A[Power ON] --> B[PV]
    B -- "Press the [Mode] Key." --> C[SP]
    C -- "Press the [Mode] Key." --> D[Alarm value 1]
    D -- "Press the [Mode] Key." --> E[Input shift value]
    E -- "Press the [Mode] Key." --> B
    
```

This item is not displayed when the Control Mode Switch 4 is OFF.

The display switches each time the [Mode] Key is pressed.

Lights when the control output is ON.

ALM1 (Alarm 1): Lights when the alarm 1 output is ON.
ALM2 (Alarm 2): For future use.

Pressing the Up Key increases the SP/alarm value display. Keeping the Up Key pressed continues to increase the display value. When the internal protect switch is ON, press the Up Key while holding down the Lock Release Key.

Pressing the Down Key decreases the SP/alarm value display. Keeping the Down Key pressed continues to decrease the display value. When the internal protect switch is ON, press the Down Key while holding down the Lock Release Key.

When the protect switch is ON, the set value can be changed by pressing the Up and Down Keys while holding down the Lock Release Key.

PV, SP, Alarm Value, Input Shift Display

Output indicator

Alarm indicators

Up Key

Down Key

Lock Release Key

Settings before Turning ON the Power

E5CSV

Remove the E5CSV from the case to make the settings.

1. Insert the tool into the two tool insertion holes (one on the top and one on the bottom) and release the hooks.

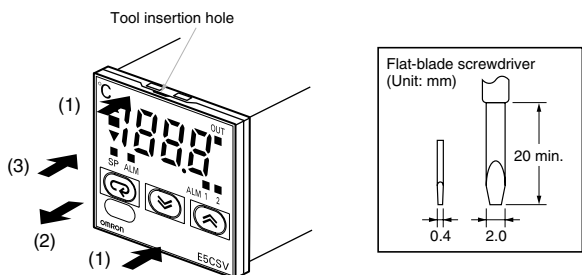

2. Insert the tool in the gap between the front panel and rear case, and pull out the front panel slightly. Grip the front panel and pull out fully. Be sure not to impose excessive force on the panel.

3. When inserting the E5CSV, check to make sure that the sealing rubber is in place and push the E5CSV toward the rear case until it snaps into position. While pushing the E5CSV into place, push down on the hooks on the top and bottom surfaces of the rear case so that the hooks are securely locked in place. Make sure that electronic components do not come into contact with the case.

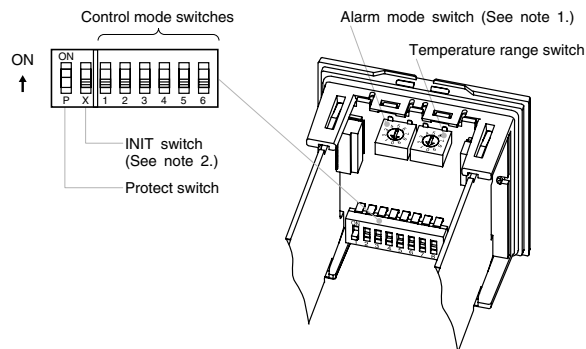

Note: 1. The INIT switch is always OFF during normal operation.

1. Sensor Type Specification

Multi-input (Thermocouple/Platinum Resistance Thermometer) Models

• Using Thermocouple Sensors, Control Mode Switch 5: OFF

Input	K	J	L	T	U	N	R
SP range	1,300	850	850	400	199.9	400	1,300
Setting number	0	1	2	3	4	5	6

• The control range is -20°C to +20°C of the input temperature range.

- Note: 1.** The input indication range is the range that can be displayed for the control range (-99 to 1999). If the input is within the control range but exceeds the display range (-99 to 1999), values below -99 will be displayed as “㇏㇏㇏” and values above 1,999 will be displayed as “㇏㇏㇏”.
- 2.** If unit is changed to 1 degree when the SP and alarm value for the temperature range are displayed in 0.1-units from 0.0 to 199.9 or 0.0 to 99.9, the values will be multiplied by 10 (e.g., 0.5 becomes 5). If the unit is changed in the reverse direction, the values will be divided by 10. After changing the range, set the SP and alarm value again.

• Using Platinum Resistance Thermometers, Control Mode Switch 5: ON

Input	Pt100					JPt100				
SP range	850	199.9	99	200	400	500	199.9	99	200	400
Setting number	0	1	2	3	4	5	6	7	8	9

• The control range is -20°C to +20°C of the input temperature range.

- Note: 1.** The input indication range is the range that can be displayed for the control range (-99 to 1999). If the input is within the control range but exceeds the display range (-99 to 1999), values below -99 will be displayed as “㇏㇏㇏” and values above 1,999 will be displayed as “㇏㇏㇏”.
- 2.** If unit is changed to 1 degree when the SP and alarm value for the temperature range are displayed in 0.1-units from 0.0 to 199.9 or 0.0 to 99.9, the values will be multiplied by 10 (e.g., 0.5 becomes 5). If the unit is changed in the reverse direction, the values will be divided by 10. After changing the range, set the SP and alarm value again.

Mode Key Display Order

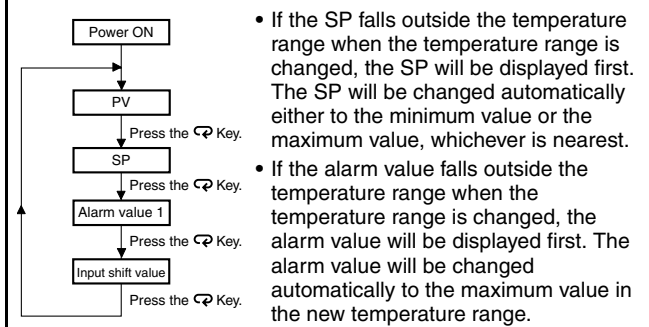

ST (Self-tuning) Features

ST (self-tuning) is a function that finds PID constants by using step response tuning (SRT) when Controller operation begins or when the set point is changed. Once the PID constants have been calculated, ST is not executed when the next control operation is started as long as the set point remains unchanged. When the ST function is in operation, be sure to turn ON the power supply of the load connected to the control output simultaneously with or before starting Controller operation.

Executing AT (Auto-tuning)

AT (auto-tuning) is executed by pressing the Up and Down Keys for at least 2 s while the PV is displayed. The deviation indicators flash during auto-tuning (AT) execution. AT will be cancelled by performing the same operation that AT is executing during AT operation. Flashing stops when AT is completed.

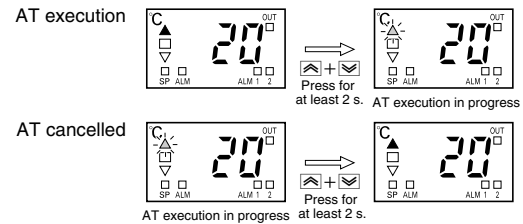

Note: One of the deviation indicators (▲▼) will flash.

Electrical Life Expectancy Curve for Relays (Reference Values)

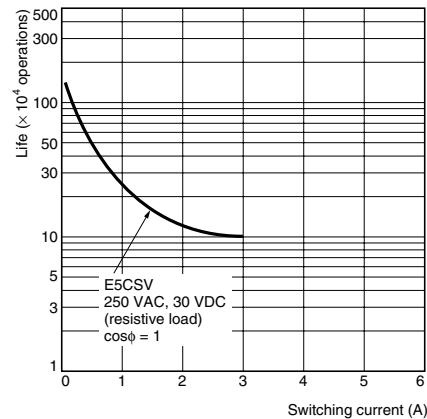

2. Operation Settings

Use the control mode switches () to change the control mode. (All switches are OFF for the default settings.)







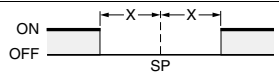
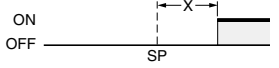

Function selection		1	2	3	4	5	6
ON/OFF PID	PID control	ON					
	ON/OFF control	OFF					
Control period	2 s		ON				
	20 s		OFF				
Direct/reverse operation	Direct operation (cooling)			ON			
	Reverse operation (heating)			OFF			
Input shift display	Enabled				ON		
	Disabled				OFF		
Temperature Sensor selection	Platinum resistance thermometer input					ON	
	Thermocouple input					OFF	
Temperature unit	°F						ON
	°C						OFF

Note: The previous name Pt100 has been changed to JPt100 in accordance with revisions to JIS. The previous name J-DIN has been changed to L in accordance with revisions to DIN standards.

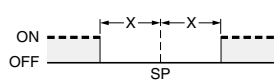
3. Alarm Modes

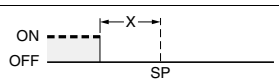
Select the number of the alarm mode switch  when changing the alarm mode. (The default is 2).

Set value	Alarm type	Alarm output operation
0, 9	Alarm function OFF	OFF
1	Upper- and lower-limit	
2	Upper-limit	
3	Lower-limit	
4	Upper- and lower-limit range	
5	Upper- and lower-limit with standby sequence (See note 2.)	
6	Upper-limit with standby sequence (See note 2.)	
7	Lower-limit with standby sequence (See note 2.)	
8	Absolute-value upper-limit	

Note: 1. No alarm. The alarm value (alarm operation display) will not be displayed when the setting is 0 or 9 even if the selection key is pressed.
Alarm Setting Range
X: 0 to FS (full scale); Y: Within temperature range
The value of X is the deviation setting for the SP (set point).
2. Standby Sequence Function (The standby sequence operates when the power is turned ON.)

Rising Temperature

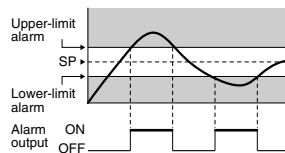

Dropping Temperature

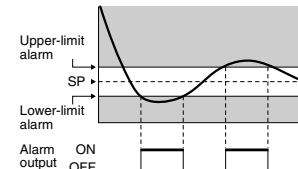

Note: Turn OFF the power before changing the DIP switch settings on the E5CSV. Each of the switch settings will be enabled after the power is turned ON.

For details on the position of the temperature range switch, control mode switches, and alarm mode switch, refer to page 4.

4. Using the Control Mode Switches

(1) Using ON/OFF Control and PID Control

(1.1) ON/OFF Control

The control mode is set to ON/OFF control as the default setting.

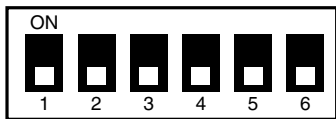

Switch 1 OFF: ON/OFF control

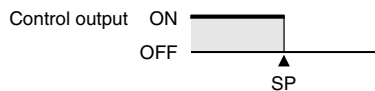

To perform cooling control of freezers, etc., turn ON switch 3.

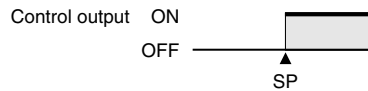
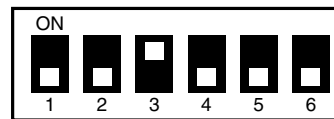

(1.2) PID Control

Turn ON switch 1 to use PID control.



Switch 1 ON: PID control

1. Set the control period.
Performing Control via Relay Output, External Relay, or Conductor

Switch 2: OFF (control period: 20 s)

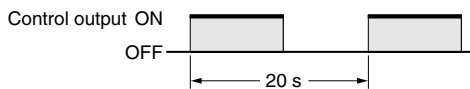

Quick Control Response Using an SSR

Switch 2: ON (control period: 2 s)

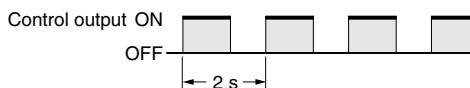

2. Set direct/reverse operation for the output.
Performing Heating Control for Heaters

Switch 3: OFF

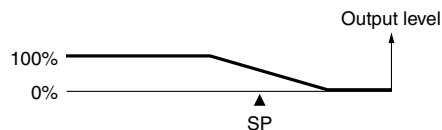
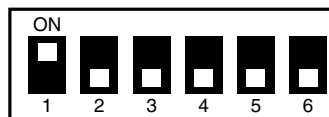

Performing Cooling Control for Freezers

Switch 3: ON

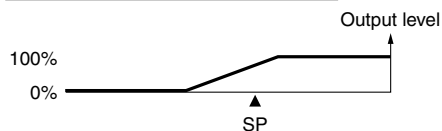
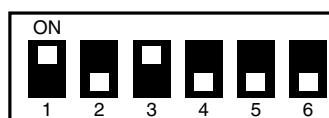

(2) Using the E5CSV in Devices for Fahrenheit-scale Users

(Displaying in °F)

Turn ON switch 6 to display temperatures in °F.



Temperature Range for °F

The temperature is set to °F using the same temperature range switch as °C.

Multi-input (Thermocouple/Platinum Resistance Thermometer)

Control mode switch 5: OFF

Setting		°F
0	K	-99 to 1999
1		0.0 to 199.9
2	J	-99 to 1500
3		0.0 to 199.9
4	L	-99 to 1500
5	T	-99 to 700
6		0.0 to 199.9
7	U	-99 to 700
8	N	-99 to 1999
9	R	0 to 1999

Multi-input (Thermocouple/Platinum Resistance Thermometer)

Control mode switch 5: ON

Setting		°F
0	Pt100	-99 to 1500
1		0.0 to 199.9
2		-99 to 99
3		0 to 200
4		0 to 400
5	JPt100	-99 to 900
6		0.0 to 199.9
7		-99 to 99
8		0 to 200
9		0 to 400

Note: The control range for multi-input (thermocouple/platinum resistance thermometer) models is -40 to +40° F of each temperature range. The previous name J-DIN has been changed to L in accordance with revisions to DIN standards.

(3) Setting Input Shift

Turn ON switch 4, and after turning ON the power, press the Mode Key until *HD* (indicates input shift of 0) is displayed. Press the Up and Down Keys to set the shift value.



Shift Example

Input shift display	Measured temperature	Temperature display
<i>HD</i> (no shift)	100° C	100° C
<i>HS</i> (+9° C shift)	100° C	109° C
<i>LS</i> (-9° C shift)	100° C	91° C

Note: When control mode switch 4 is turned OFF (no input shift display), the input shift is not displayed but the shift value is enabled. To disable input shift, set the input shift value to *HD*. The shift range depends on the setting unit.

Setting unit	1° C	0.1° C
Compensation range	-99 to +99° C	-9.9 to +9.9° C
Input shift display	L99 to H99	L9.9 to H9.9

5. Protect Switch

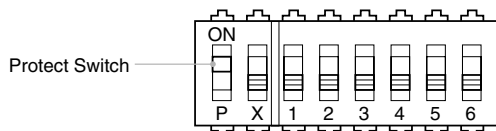

When the protect switch is ON, Up Key and Down Key operations are prohibited to prevent setting mistakes.

OMRON EUROPE B.V. Wegalaan 67-69, NL-2132 JD, Hoofddorp, The Netherlands. Tel: +31 (0) 23 568 13 00 Fax: +31 (0) 23 568 13 88 www.omron-industrial.com

Austria

Tel: +43 (0) 1 80 19 00
www.omron.at

Belgium

Tel: +32 (0) 2 466 24 80
www.omron.be

Czech Republic

Tel: +420 234 602 602
www.omron.cz

Denmark

Tel: +45 43 44 00 11
www.omron.dk

Finland

Tel: +358 (0) 207 464 200
www.omron.fi

France

Tel: +33 (0) 1 56 63 70 00
www.omron.fr

Germany

Tel: +49 (0) 2173 680 00
www.omron.de

Hungary

Tel: +36 (0) 1 399 30 50
www.omron.hu

Italy

Tel: +39 02 32 68 1
www.omron.it

Middle East & Africa

Tel: +31 (0) 23 568 11 00
www.omron-industrial.com

Netherlands

Tel: +31 (0) 23 568 11 00
www.omron.nl

Norway

Tel: +47 (0) 22 65 75 00
www.omron.no

Poland

Tel: +48 (0) 22 645 78 60
www.omron.pl

Portugal

Tel: +351 21 942 94 00
www.omron.pt

Russia

Tel: +7 495 745 26 64
www.omron.ru

Spain

Tel: +34 913 777 900
www.omron.es

Sweden

Tel: +46 (0) 8 632 35 00
www.omron.se

Switzerland

Tel: +41 (0) 41 748 13 13
www.omron.ch

Turkey

Tel: +90 (0) 216 474 00 40
www.omron.com.tr

United Kingdom

Tel: +44 (0) 870 752 08 61
www.omron.co.uk

Authorised Distributor:

Control Systems

- Programmable logic controllers • Human-machine interfaces • Remote I/O

Motion & Drives

- Motion controllers • Servo systems • Inverters

Control Components

- Temperature controllers • Power supplies • Timers • Counters • Programmable relays
- Digital panel indicators • Electromechanical relays • Monitoring products • Solid-state relays
- Limit switches • Pushbutton switches • Low voltage switch gear

Sensing & Safety

- Photoelectric sensors • Inductive sensors • Capacitive & pressure sensors • Cable connectors
- Displacement & width-measuring sensors • Vision systems • Safety networks • Safety sensors
- Safety units/relay units • Safety door/guard lock switches