

■ Cautions

Use the DIP Switch within the rated voltage and current ranges, otherwise the DIP Switch may have a shortened life expectancy, radiate heat, or burn out. This particularly applies to the instantaneous voltages and currents when switching.

■ Correct Use

CIRCUIT DESIGN

Although the minimum current is 10 mA (3.5 VDC), contact reliability may need to be improved in some cases. This is particularly true when switching causes an increase in instantaneous current, such as in C-MOS IC applications. Do not let the peak current exceed the rated value here or any other time.

Only BCD/hexadecimal 1-2-4-8 code is available for A6C/A6CV/A6R/A6RV models. If BCD/hexadecimal 1-2-4-8 complement code is required, make the appropriate provisions in the circuit.

MOUNTING

Normally the default striker setting is OFF for slide-type DIP Switches and the default rotor setting is 0 for Rotary DIP Switches. Do not change these settings when mounting, soldering, washing or drying Switches. In rare cases, the striker may be deformed by heat generated during soldering.

Automatic Insertion Machine

Use a body stopper system for the chute stopper of automatic insertion machines. When mounting Switches using an insertion machine incorporating a half-lead stopper, make sure the machine will not deform the terminals of the Switch, or improper insertion may result. Check actual mounting conditions prior to using a half-lead stopper system.

A printed circuit board that is 1.2 to 1.6 mm thick is recommended.

Holes on the PCB should be at least 0.9 mm in diameter for automatic insertion.

Manual or IC Socket Insertion

Commercially available insertion tools are recommended for mounting ICs on PCBs.

Terminal pitch, dimensions and other features are identical to that of standard ICs for IC socket compatibility (except for the A6H and A6S).

Align the terminals so they slide in simultaneously when the Switch is inserted into socket holes or into mounting holes pre-drilled at the specified dimensions. Apply downward force on the Switch until the terminals are properly seated on the PCB.

Do not try to remove a Switch by inserting a screwdriver between it and the PCB, and then twisting the screwdriver to peel the Switch off. Use a commercially available inserter/remover to remove the Switch.

SOLDERING

Observe the following conditions when soldering the DIP Switch.

General Precautions for Soldering

Set the pins to OFF before soldering an A6ER DIP Switch.

Before soldering the Switch on a PCB, make sure there is no unnecessary space between the Switch and the PCB.

Before soldering the Switch on a multilayer PCB, conduct a test to make sure the Switch will not be deformed by soldering heat on the pattern or land of the multilayer PCB.

Automatic Soldering Bath (Except A6S/A6H)

Soldering temperature: 260°C max.

Soldering time: 5 s max. for a 1.6-mm thick, single-side PCB

Do not use an automatic soldering bath or manual soldering for A6S or A6H models.

Confirm in advance that flux will not bubble up onto the side of the PCB to which the Switch is mounted. Depending on the type of Switch, the flux may have an adverse effect if it enters the Switch.

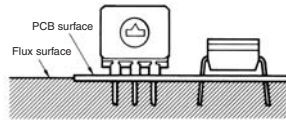

The A6S and A6H are designed specifically for reflow soldering. Do not use an automatic soldering bath or manual soldering for these models.

Reflow Soldering

Observe the following conditions for reflow soldering the A6S and A6H models.

A6S

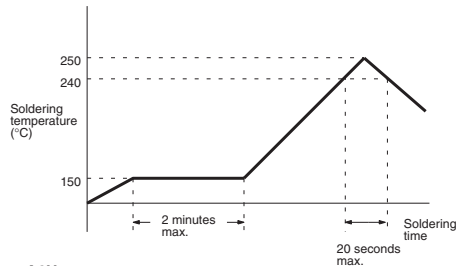

A6H

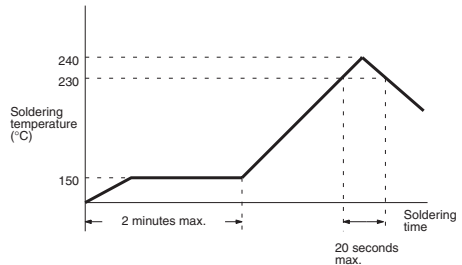

Do not use reflow soldering for any models other than the A6S and A6H. Otherwise the plastic case may melt or deform.

The soldering conditions and the temperature around the Switch may vary with the type of reflow bath. Check the temperature profile and confirm soldering conditions as well as the amount of heat applied to the Switch prior to soldering.

Manual Soldering (Except A6S/A6H)

Soldering temperature: 350°C at the tip of the soldering iron.

Soldering time: 3 s max. for a 1.6-mm thick, single-side PCB

Do not solder the Switch more than twice including any rectification soldering. An interval of five minutes is required between the first and second soldering

Technical Information – DIP Switches

WASHING

Washable and Non-washable Models

The models for which washing are possible are shown in the following table.

Washable	A6A, A6C, A6CV, A6D, A6DR, A6T (with seal tape), A6S (with seal tape), A6H (with seal tape)
Non-washable	A6R, A6RV, A6T (standard/raised actuator), A6S (standard/raised actuator), A6E, A6ER

Washing Procedure

Ultrasonic cleaning is not available for slide-type DIP Switches with seal tape. These models may be wiped or dipped into washing agents for one minute maximum.

Slide-type DIP Switches with seal tape can be washed as long as the seal tape is not removed or pasted before washing. Non-compliance here will cause the quality of the seal to decline.

Washing equipment incorporating more than one washing bath can be used to clean washable models, provided that the washable models are cleaned for one minute maximum per bath and the total cleaning time does not exceed three minutes.

Washing Agents

Apply alcohol-based solvents to clean washable models. Do not apply water or any other agents to clean any washable models, as such agents may degrade the materials or performance of the Switch.

Washing Precautions

Do not impose any external force on washable models while washing.

Do not clean washable models immediately after soldering. The cleaning agent may be absorbed into the incomplete seal through respiration as the Switch cools. Wait for at least three minutes after soldering before cleaning.

Do not use washable Switches submerged in water or in locations exposed to water.

HANDLING

Slide-type DIP Switch operation

Do not apply excessive operating force to the Switch. Otherwise the Switch may be damaged or deformed, and the switch mechanism may malfunction as a result. Apply an operating force not exceeding 200% of the maximum rated operating force to the Switch.

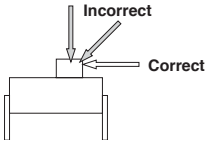

Set slide-type DIP Switches with a tiny, rounded object, such as the tip of a ball-point pen or a small screwdriver. Do not set the DIP Switch using tweezers or any other sharp object that may damage it. Do not set the DIP Switch using the point of a

mechanical pencil, or lead powder or fragments may fall into the Switch and internal circuit board, causing the DIP Switch to malfunction and reducing the dielectric strength of the circuit board.

Although raised-type (A6B standard type) and piano-type strikers can be operated by fingertip, do not push too hard or too fast because this will deform or damage the striker.

Rotary DIP Switch Operation

Set rotary-type DIP Switches with a flat-blade screwdriver that fits into the screwdriver groove. Using a screwdriver of inappropriate dimensions, or using a tool other than a flat-blade screwdriver may cause damage to the groove that may make the Switch impossible to operate.

Insert the flat-blade screwdriver vertically to operate the Switch. The Switch may be damaged if the screwdriver is inserted at an angle.

Do not use excessive force to operate the Switch, or it may damage or deform the Switch.

Item	A6R/A6RV	A6A		A6C/A6CV
	Top/Side operation, flat type	Standard type, flat type	Shaft type, wheel type	Top/Side operation type
Screwdriver groove	Depth: 1.0	Depth: 0.9	Depth: 0.9	Depth: 1.0
Applicable screwdriver: A	1.8 to 2.1	3.5 to 3.8		2.0 to 2.4
Applicable screwdriver: B	0.7 to 0.8	0.4 to 0.5		0.5 to 0.6
Part Names				

Note: All units are in millimetres unless otherwise indicated.

■ Packing specifications

- A6S models with embossed tapping specifications are shown below

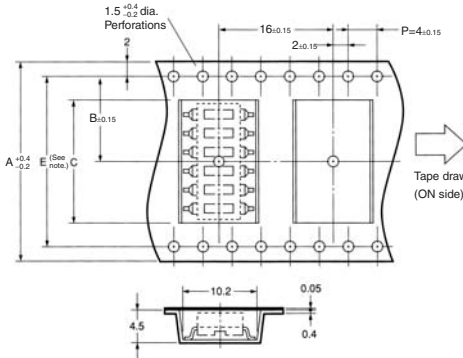

- A6H models with embossed tapping specifications are shown below

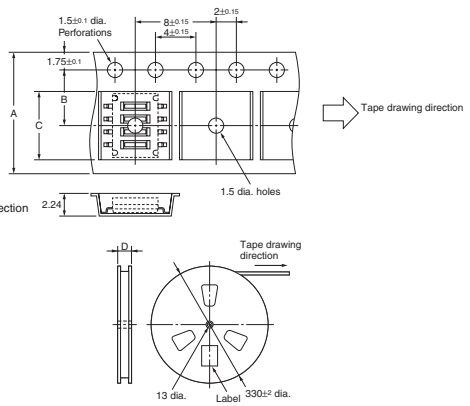

Note: The perforations along both sides are for 8-pole Switches only. The perforations on the bottom of the diagram are not for 4- and 6-pole Switches.

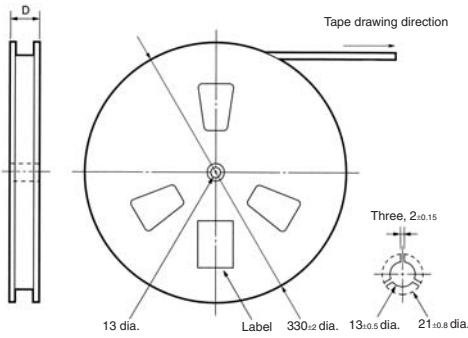



Applicable Models	A6H-□102-P
Standard	Conforms to JEITA.
Package Quantity	4,000 per reel

No. of Poles	4	6	8	10
$A^{+0.3}_{-0.1}$	12	24	24	24
$B \pm 0.15$	5.5	11.5	11.5	11.5
C	(6.6)	(11.7)	(11.7)	(14.4)
D	(18)	(30)	(30)	(30)



Applicable Models	A6S-□102-P
Standard	Conforms to JEITA.
Package Quantity	900 per reel

No. of Poles	4	5	6
$A^{+0.4}_{-0.2}$	24	24	32
$B \pm 0.15$	11.5	11.5	14.2
C	11.6	16.7	21.7
D	(30)	(30)	(38)
E	-	-	28.4



Selection Guide – DIP Switches

Model		A6H			A6S			
Appearance								
Actuator		Flat			Flat			Raised
Seal Tape		–	Seal tape		–	Seal tape		–
		Stick	Stick	Embossed taping (units of 4,000)	Stick	Stick	Embossed taping (units of 900) (see note)	Stick
Terminal		SMT			SMT			
Automatic mounting		Yes						
Washable		No	Yes	Yes	No	Yes	Yes	No
No. of poles	1	–	–	–	–	–	–	–
	2	–	–	–	A6S-2101	A6S-2102	–	A6S-2104
	3	–	–	–	A6S-3101	A6S-3102	–	A6S-3104
	4	A6H-4101	A6H-4102	A6H-4102-P	A6S-4101	A6S-4102	A6S-4102-P	A6S-4104
	5	–	–	–	A6S-5101	A6S-5102	–	A6S-5104
	6	A6H-6101	A6H-6102	A6H-6102-P	A6S-6101	A6S-6102	A6S-6102-P	A6S-6104
	7	–	–	–	A6S-7101	A6S-7102	–	A6S-7104
	8	A6H-8101	A6H-8102	A6H-8102-P	A6S-8101	A6S-8102	A6S-8102-P	A6S-8104
	9	–	–	–	A6S-9101	A6S-9102	–	A6S-9104
	10	A6H-0101	A6H-0102	A6H-0102-P	A6S-0101	A6S-0102	–	A6S-0104
Page		665			667			

Note: Embossed taping specifications are available for A6S models with 4, 6, and 8 poles. (When ordering add “-P” to the model number.)











Model		A6T			A6D	
Appearance						
Actuator		Flat		Raised	Flat	Raised
Seal tape		–	Seal tape		–	Internal seal tape
Terminal		DIP				
Automatic mounting		Yes				
Washable		No	Yes	No	Yes	Yes
No. of poles	1	A6T-1101	A6T-1102	A6T-1104	–	–
	2	A6T-2101	A6T-2102	A6T-2104	A6D-2100	A6D-2103
	3	A6T-3101	A6T-3102	A6T-3104	–	–
	4	A6T-4101	A6T-4102	A6T-4104	A6D-4100	A6D-4103
	5	A6T-5101	A6T-5102	A6T-5104	–	–
	6	A6T-6101	A6T-6102	A6T-6104	A6D-6100	A6D-6103
	7	A6T-7101	A6T-7102	A6T-7104	–	–
	8	A6T-8101	A6T-8102	A6T-8104	A6D-8100	A6D-8103
	9	A6T-9101	A6T-9102	A6T-9104	–	–
	10	A6T-0101	A6T-0102	A6T-0104	A6D-0100	A6D-0103
Page		667			670	

Selection Guide – DIP Switches

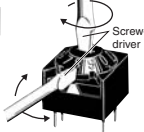
Model		A6E		A6DR
Appearance				
Actuator		Flat		Raised
Seal tape		–		Internal seal tape
Terminal		DIP		DIP
Automatic mounting		No		No
Washable		No		Yes
No. of poles	1	–		–
	2	A6E-2101	A6E-2104	A6DR-2100
	3	A6E-3101	A6E-3104	–
	4	A6E-4101	A6E-4104	A6DR-4100
	5	A6E-5101	A6E-5104	–
	6	A6E-6101	A6E-6104	A6DR-6100
	7	A6E-7101	A6E-7104	–
	8	A6E-8101	A6E-8104	A6DR-8100
	9	A6E-9101	A6E-9104	–
	10	A6E-0101	A6E-0104	A6DR-0100
Page		673		670

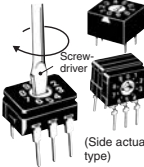
Model		A6ER	
Appearance			
Actuator		Side (short-lever)	Side (long-lever)
Seal tape		–	
Terminal		DIP	
Automatic mounting		No	
Washable		No	No
No. of poles	1	–	
	2	A6ER-2101	A6ER-2104
	3	A6ER-3101	A6ER-3104
	4	A6ER-4101	A6ER-4104
	5	A6ER-5101	A6ER-5104
	6	A6ER-6101	A6ER-6104
	7	A6ER-7101	A6ER-7104
	8	A6ER-8101	A6ER-8104
	9	A6ER-9101	A6ER-9104
	10	A6ER-0101	A6ER-0104
Page		673	

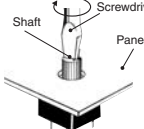

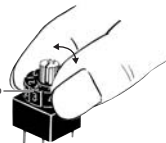
Selection Guide – DIP Switches

Model		A6A		A6C		A6CV		
Appearance								
Seal tape		Internal seal tape						
Terminals		DIP						
No. of switching positions		10	16	10	16	10	16	
Type	Standard type   The rotary switch can be turned from the top or the side.	BCD/ hexadecimal 1-2-4-8 (see note 1)	A6A-10R	A6A-16R	-		-	
		BCD/ hexadecimal 1-2-4-8 complement (see note 2)	A6A-10C	A6A-16C	-		-	
Flat type   (Side actuated type) Switching part contained within flat surface. No raised edges allows space saving.	BCD/ hexadecimal 1-2-4-8	A6A-10RF	A6A-16RF	A6C-10R (N)	A6C-16R (N)	A6CV-10R	A6CV-16R	
		BCD/ hexadecimal 1-2-4-8 complement	A6A-10CF	A6A-16CF	-		-	
Extended shaft type   Extended shaft enables switching to be performed outside the device through a panel or another kind of cover.	BCD/ hexadecimal 1-2-4-8	A6A-10RS	A6A-16RS	-		-		
		BCD/ hexadecimal 1-2-4-8 complement	A6A-10CS	A6A-16CS	-		-	
Thumbwheel type   Thumbwheel allows easy switching using fingers.	BCD/ hexadecimal 1-2-4-8	A6A-10RW	A6A-16RW	-		-		
		BCD/ hexadecimal 1-2-4-8 complement	A6A-10CW	A6A-16CW	-		-	
Page		676		680		680		

Note 1: "BCD/hexadecimal 1-2-4-8" is a binary code that takes the value 1 for voltages that are high with respect to ground and takes the value 0 for voltages that are low with respect to ground.

Note 2: "BCD/hexadecimal 1-2-4-8 complement" is a binary code that take the opposite value to "BCD/hexadecimal 1-2-4-8," i.e., takes the value 0 for high voltages and 1 for low voltages.

Selection Guide – DIP Switches

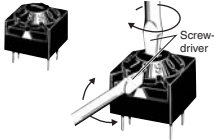
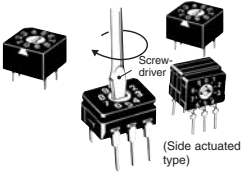
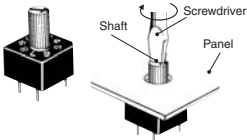
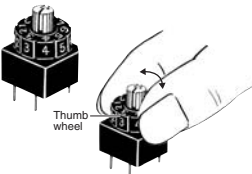
Model	A6R		A6RV		
Appearance					
Seal tape	-				
Terminals	DIP				
No. of switching positions	10	16	10	16	
<p>Type</p> <p>Standard type</p>  <p>The rotary switch can be turned from the top or the side.</p>	<p>BCD/ hexadecimal 1-2-4-8 (see note 1)</p> <p>BCD/ hexadecimal 1-2-4-8 complement (see note 2)</p>				
<p>Flat type</p>  <p>Switching part contained within flat surface. No raised edges allows space saving.</p>	<p>BCD/ hexadecimal 1-2-4-8</p> <p>BCD/ hexadecimal 1-2-4-8 complement</p>	<p>A6R-101RF A6R-102RF</p>	<p>A6R-161RF A6R-162RF</p>	<p>A6RV-101RF A6RV-102RF</p>	<p>A6RV-161RF A6RV-162RF</p>
<p>Extended shaft type</p>  <p>Extended shaft enables switching to be performed from outside the device through a panel or another kind of cover.</p>	<p>BCD/ hexadecimal 1-2-4-8</p> <p>BCD/ hexadecimal 1-2-4-8 complement</p>	<p>A6R-101RS A6R-102RS</p>	<p>A6R-161RS A6R-162RS</p>	<p>A6RV-101RS A6RV-102RS</p>	<p>A6RV-161RS A6RV-162RS</p>
<p>Thumbwheel type</p>  <p>Thumbwheel allows easy switching using fingers.</p>	<p>BCD/ hexadecimal 1-2-4-8</p> <p>BCD/ hexadecimal 1-2-4-8 complement</p>				
Page	683		683		

Note 1: “BCD/hexadecimal 1-2-4-8” is a binary code that takes the value 1 for voltages that are high with respect to ground and takes the value 0 for voltages that are low with respect to ground.



Note 2: “BCD/hexadecimal 1-2-4-8 complement” is a binary code that take the opposite value to “BCD/hexadecimal 1-2-4-8,” i.e., takes the value 0 for high voltages and 1 for low voltages.

Ultra-low Profile, Half-pitch, Surface-mounting DIP Switch

- ROHS compliant.
- Very low profile of 1.55 mm.
- Mounting space reduced by 63% (compared with conventional models).
- Washable, seal tape models available.
- Embossed tapping models available.



Ordering Information

Type (striker color)		Standard models (White)	Models with seal tape (White)	
			Stick models	Embossed tapping models (See note)
No. of poles	Quantity per stick			
4	75	A6H-4101	A6H-4102	A6H-4102-P
6	54	A6H-6101	A6H-6102	A6H-6102-P
8	40	A6H-8101	A6H-8102	A6H-8102-P
10	33	A6H-0101	A6H-0102	A6H-0102-P

Note: Embossed tapping models are packaged in units of 4,000. Orders must be made in multiples of 4,000. Switches are not sold individually.

Specifications

■ Rating/Characteristics

Switching capacity	25 mA at 24 VDC 10 μ A (minimum current) at 3.5 VDC
Ambient temperature	Operating: 20 to 70°C (with no icing or condensation) Storage: -40 to 85°C (with no icing or condensation)
Ambient humidity	Operating: 35% to 90%
Insulation resistance	100 M Ω min. (at 250 VDC)
Contact resistance	200 m Ω max. (initial value)
Dielectric strength	300 VAC for 1 min between terminals of the same polarity, and between terminals of different polarity
Vibration resistance	Malfunction: 10 to 55 Hz, 1.5-mm double amplitude
Shock resistance	Malfunction: 300 m/s ² min.
Life expectancy	Mechanical: 1,000 operations min. Electrical: 1,000 operations min.
Operating force	0.29 to 0.49 N
Enclosure rating	Equivalent to IP40
Weight	0.09 g (4 poles) 0.12 g (6 poles) 0.15 g (8 poles) 0.18 g (10 poles)

Half-Pitch DIP Switch (SMD Type) – A6H

Dimensions

Note 1: All units are in millimetres unless otherwise indicated.

2: Unless otherwise specified, a tolerance of ± 0.4 mm applies to all dimensions.

Standard

A6H-□101

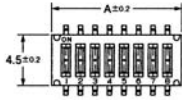

Dimensions of PCB pad (Top View)

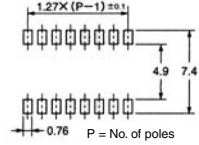

With Seal Tape

A6H-□102
A6H-□102-P

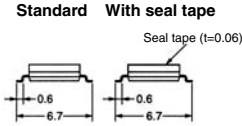
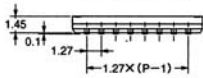
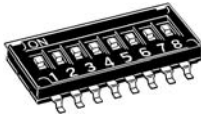

No. of poles	Model		Dimension A
4	A6H-4101	A6H-4102	6.31
6	A6H-6101	A6H-6102	8.85
8	A6H-8101	A6H-8102	11.39
10	A6H-0101	A6H-0102	13.93

Installation

Internal Connections (Top View)

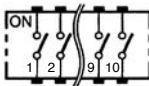

ALL DIMENSIONS SHOWN ARE IN MILLIMETRES.

To convert millimetres into inches, multiply by 0.03937. To convert grams into ounces, multiply by 0.03527.

DIP Switch (Slide Type) – A6T/A6S

Low-cost DIP Switch with Slide Pins

- Designed to DIP (Dual Inline Package) standards and allows automatic mounting with IC insertion machines.
- Washable models with seal tape available.
- SMT (surface-mounted terminal) models available with embossed taping specifications (units of 900).
- Gold-plated twin contacts and a slide-type, self-cleaning mechanism ensure high reliability.

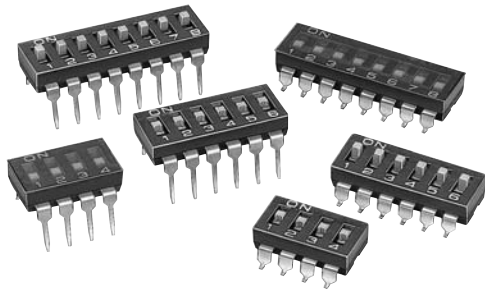

Ordering Information

Type (striker color)		Flat actuator (Yellow)		Raised actuator (Yellow)	Type (striker color)		Flat actuator (Yellow)		Raised actuator (Yellow) (See note 2)
		Standard	With seal tape				Standard	With seal tape	
		DIP terminal	DIP terminal	DIP terminal			DIP terminal	DIP terminal	DIP terminal
No. of poles	Quantity per stick			No. of poles	Quantity per stick	Per stick	Per embossed tape (units of 900) (See note 1)		
1	130	A6T-1101	A6T-1102	A6T-1104	1	–	–	–	–
2	76	A6T-2101	A6T-2102	A6T-2104	2	76	A6S-2101	A6S-2102	A6S-2104
3	55	A6T-3101	A6T-3102	A6T-3104	3	55	A6S-3101	A6S-3102	A6S-3104
4	42	A6T-4101	A6T-4102	A6T-4104	4	42	A6S-4101	A6S-4102	A6S-4102-P A6S-4104
5	35	A6T-5101	A6T-5102	A6T-5104	5	35	A6S-5101	A6S-5102	A6S-5105
6	28	A6T-6101	A6T-6102	A6T-6104	6	28	A6S-6101	A6S-6102	A6S-6102-P A6S-6104
7	25	A6T-7101	A6T-7102	A6T-7104	7	25	A6S-7101	A6S-7102	A6S-7104
8	22	A6T-8101	A6T-8102	A6T-8104	8	22	A6S-8101	A6S-8102	A6S-8102-P A6S-8104
9	20	A6T-9101	A6T-9102	A6T-9104	9	20	A6S-9101	A6S-9102	A6S-9104
10	18	A6T-0101	A6T-0102	A6T-0104	10	18	A6S-0101	A6S-0102	A6S-0102-P A6S-0104

Note 1: Switches are packaged in units of 900. Orders must be made in multiples of 900. Switches are not sold individually.

Note 2: Raised actuators on embossed tape must be requested separately because orders can vary by such factors as units per order.

Specifications

■ Rating/Characteristics

Switching capacity	25 mA at 24 VDC 10 μ A (minimum current) at 3.5 VDC
Ambient temperature	Operating: -20°C to 70°C (with no icing)
Ambient humidity	Operating: 35% to 90%
Insulation resistance	100 M Ω min. (at 250 VDC)
Contact resistance	200 m Ω max. (initial value)
Dielectric strength	500 VAC for 1 min between terminals of the same polarity, and between terminals of different polarity
Vibration resistance	Malfunction: 10 to 55 Hz, 1.5-mm double amplitude
Shock resistance	Malfunction: 300 m/s ² min.
Life expectancy	Mechanical: 1,000 operations min. Electrical: 1,000 operations min.
Operating force	Flat/raised type 0.29 N min. {30 gf}
Weight	A6T: 0.26 g (2 poles), 0.44 g (4 poles), 0.62 g (6 poles), 0.79 g (8 poles), 0.96 g (10 poles) A6S: 0.25 g (2 poles), 0.41 g (4 poles), 0.58 g (6 poles), 0.73 g (8 poles), 0.87 g (10 poles)

Dimensions

Note 1: All units are in millimetres unless otherwise indicated.

Note 2: Unless otherwise specified, a tolerance of ± 0.4 mm applies to all dimensions.

Flat Actuator with DIP Terminal Standard/With Seal Tape

A6T-□101
A6T-□102

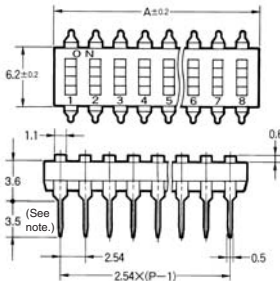
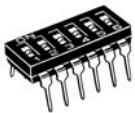

Flat Actuator
Standard

With Seal Tape
Seal tape (t = 0.06)

Raised Actuator



Raised Actuator with DIP Terminal

A6T-□104

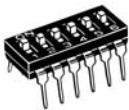

PCB Dimensions (Top View)

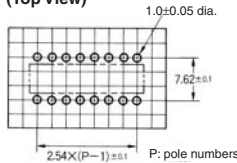

No. of poles	Model			Dimension A
1	A6T-1101	A6T-1102	A6T-1104	3.48
2	A6T-2101	A6T-2102	A6T-2104	6.02
3	A6T-3101	A6T-3102	A6T-3104	8.56
4	A6T-4101	A6T-4102	A6T-4104	11.10
5	A6T-5101	A6T-5102	A6T-5104	13.64
6	A6T-6101	A6T-6102	A6T-6104	16.18
7	A6T-7101	A6T-7102	A6T-7104	18.72
8	A6T-8101	A6T-8102	A6T-8104	21.26
9	A6T-9101	A6T-9102	A6T-9104	23.80
10	A6T-0101	A6T-0102	A6T-0104	26.34

DIP Switch (Slide Type) – A6T/A6S

Flat Actuator with SMT Terminal Standard/With Seal Tape

A6S-□101
A6S-□102

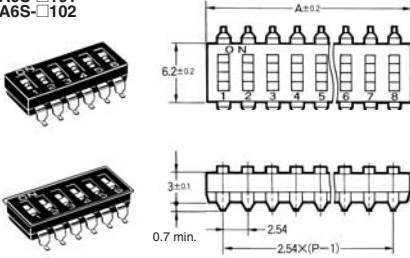

Flat Actuator
Standard

With Seal Tape

Raised Actuator

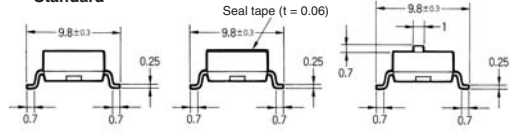

Raised Actuator with SMT Terminal

A6S-□104



PCB Dimensions
(Top View)

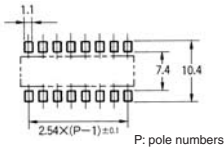

No. of poles	Model			Dimension A
2	A6S-2101	A6S-2102	A6S-2104	6.02
3	A6S-3101	A6S-3102	A6S-3104	8.56
4	A6S-4101	A6S-4102	A6S-4104	11.10
5	A6S-5101	A6S-5102	A6S-5104	13.64
6	A6S-6101	A6S-6102	A6S-6104	16.18
7	A6S-7101	A6S-7102	A6S-7104	18.72
8	A6S-8101	A6S-8102	A6S-8104	21.26
9	A6S-9101	A6S-9102	A6S-9104	23.80
10	A6S-0101	A6S-0102	A6S-0104	26.34

Installation

■ Internal Connections (Top View)

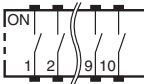

ALL DIMENSIONS SHOWN ARE IN MILLIMETRES.



To convert millimetres into inches, multiply by 0.03937. To convert grams into ounces, multiply by 0.03527.

High Performance DIP Switches with Dustproof Construction (Internally Sealed)

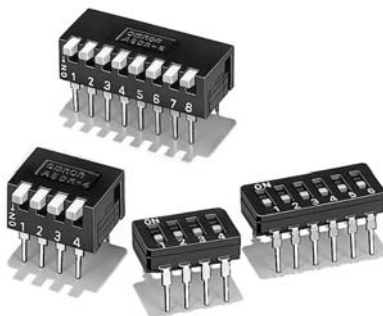
- ROHS compliant.
- Dustproof construction yields superior contact reliability.
- Designed to DIP (Dual Inline Package) standards and allows automatic mounting with IC insertion machines (Flat actuator types only).
- Smooth, sure switching action.
- Gold-plated twin contacts and a slide-type, self-cleaning mechanism ensure high reliability.



Ordering Information

Type (striker color)		Flat actuator (Yellow)	Raised actuator (Yellow)	Side actuator (Yellow)
No. of poles	Quantity per stick			
2	73	A6D-2101	A6D-2103	A6DR-2100
4	43	A6D-4100	A6D-4103	A6DR-4100
6	30	A6D-6100	A6D-6103	A6DR-6100
8	23	A6D-8100	A6D-8103	A6DR-8100
10	19	A6D-0100	A6D-0103	A6DR-0100

Note 1: The side-actuator model has a flat actuator inside.

2: Contact your OMRON sales representatives to request special markings or designations.

3: The quantity per stick applies only to A6Ds. A6DRs are packaged 50 to a box, A6DR 2 pole are packaged 100 to a box.

Specifications

Rating/Characteristics

Switching capacity	100 mA at 5 VDC and 30 mA at 30 VDC (switching current) 10 μ A at 3.5 VDC (minimum current)
Ambient temperature	Operating: -20 to 70°C (no icing)
Ambient humidity	35 to 90%
Insulation resistance	100 m Ω min. (at 250 VDC)
Contact resistance	100 m Ω max. (initial value)
Dielectric strength	500 VAC for 1 minute between terminals of the same polarity, and between terminals of different polarity
Vibration resistance	Malfunction: 10 to 55 Hz, 1.5 mm double amplitude
Shock resistance	Malfunction: 300 m/s ² min.
Life expectancy	Mechanical: 5,000 operations min. Electrical: 2,000 operations min.
Operating force	4.90 N max.
Weight	Flat and raised actuators: 0.45 g (4 poles), 0.65 g (6 poles), 0.80 g (8 poles), 1.0 g (10 poles) Side-actuators: 0.8 g (4 poles), 1.2 g (6 poles), 1.7 g (8 poles), 2.2 g (10 poles)

DIP Switch (Slide Type) – A6D/A6DR

Dimensions

Note 1: All units are in millimetres unless otherwise indicated.

2: Unless otherwise specified, a tolerance of ± 0.4 mm applies to all dimensions.

Flat Actuator

A6D-□100

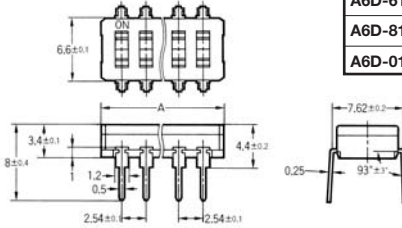
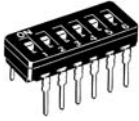

Model	Dimension A ± 0.2
A6D-2100	7.1
A6D-4100	12.2
A6D-6100	17.3
A6D-8100	22.4
A6D-0100	27.4

Raised Actuator

A6D-□103

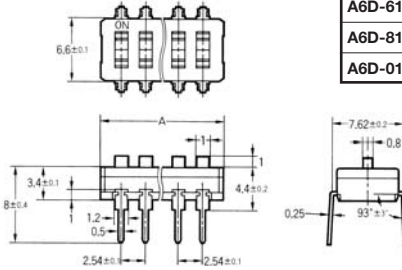
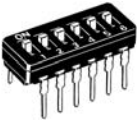

Model	Dimension A ± 0.2
A6D-2103	7.1
A6D-4103	12.2
A6D-6103	17.3
A6D-8103	22.4
A6D-0103	27.4

Side Actuator

A6DR-□100

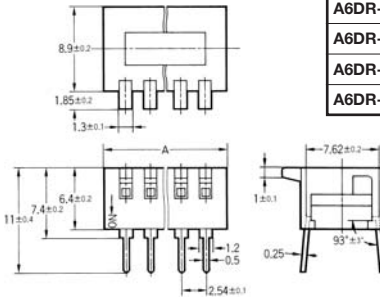
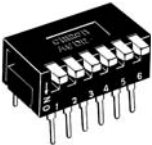

Model	Dimension A ± 0.2
A6DR-2100	7.1
A6DR-4100	12.2
A6DR-6100	17.3
A6DR-8100	22.4
A6DR-0100	27.4

Installation

■ Internal Connections (Top View)

Internal connections (top view)

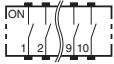

Mounting holes (top view)

(Single-sided PCB, $t=1.2$ to 1.6)

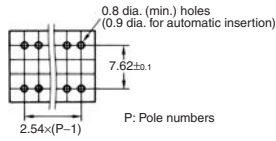

ALL DIMENSIONS SHOWN ARE IN MILLIMETRES.

To convert millimetres into inches, multiply by 0.03937. To convert grams into ounces, multiply by 0.03527.

DIP Switch – A6E/A6ER

Low-cost DIP Switch

- ROHS compliant.
- The sealed bottom prevents flux penetration.
- A variety of models with short or long actuators (levers) available.

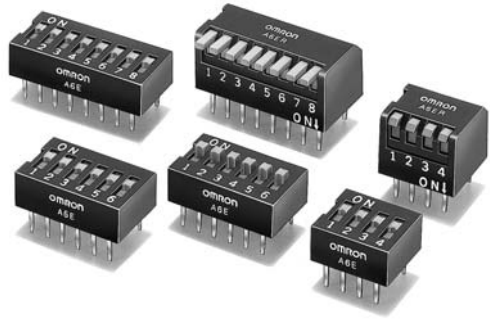

Ordering Information

Type (striker color)		Flat actuator (Yellow)	Raised actuator (Yellow)	Type	Side actuator (short-lever) (Yellow)	Side actuator (long-lever) (Yellow)
No. of poles	Quantity per stick	DIP Terminal	DIP Terminal		DIP Terminal	DIP Terminal
2	73	A6E-2101	A6E-2104	70	A6ER-2101	A6ER-2104
3	52	A6E-3101	A6E-3104	50	A6ER-3101	A6ER-3104
4	40	A6E-4101	A6E-4104	39	A6ER-4101	A6ER-4104
5	33	A6E-5101	A6E-5104	32	A6ER-5101	A6ER-5104
6	28	A6E-6101	A6E-6104	27	A6ER-6101	A6ER-6104
7	24	A6E-7101	A6E-7104	24	A6ER-7101	A6ER-7104
8	21	A6E-8101	A6E-8104	21	A6ER-8101	A6ER-8104
9	19	A6E-9101	A6E-9104	19	A6ER-9101	A6ER-9104
10	17	A6E-0101	A6E-0104	17	A6ER-0101	A6ER-0104

Specifications

■ Rating/Characteristics

Switching capacity	25 mA at 24 VDC, 10 μ A (minimum current) at 3.5 VDC
Ambient temperature	Operating: -20°C to 70°C (with no icing)
Ambient humidity	Operating: 35% to 90%
Insulation resistance	100 M Ω min. (at 250 VDC)
Contact resistance	200 m Ω max. (initial value)
Dielectric strength	500 VAC for 1 min between terminals of the same polarity, and between terminals of different polarity
Vibration resistance	Malfunction: 10 to 55 Hz, 1.5-mm double amplitude
Shock resistance	Malfunction: 300 m/s ² min.
Life expectancy	Mechanical: 1,000 operations min. Electrical: 1,000 operations min.
Operating force	0.29 N min. {30 gf}
Weight	A6E: 0.66 g (2 poles), 1.00 g (4 poles), 1.32 g (6 poles), 1.65 g (8 poles), 1.98 g (10 poles) A6ER: 1.01 g (2 poles), 1.51 g (4 poles), 2.00 g (6 poles), 2.51 g (8 poles), 3.02 g (10 poles)

Dimensions

Note 1: All units are in millimetres unless otherwise indicated.

2: Unless otherwise specified, a tolerance of ± 0.4 mm applies to all dimensions.

Flat Actuator with DIP Terminal

A6E-□101

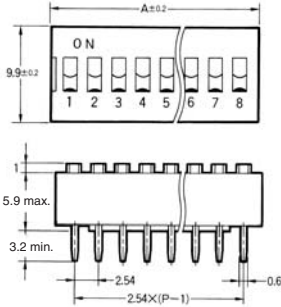

P: Pole numbers

Flat Actuator

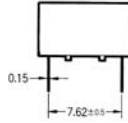

Raised Actuator

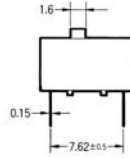

Raised Actuator with DIP Terminal

A6E-□104



PCB Dimensions (Top View)

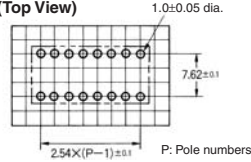

No. of poles	Model		Dimension A
2	A6E-2101	A6E-2104	6.64
3	A6E-3101	A6E-3104	9.18
4	A6E-4101	A6E-4104	11.72
5	A6E-5101	A6E-5104	14.26
6	A6E-6101	A6E-6104	16.80
7	A6E-7101	A6E-7104	19.34
8	A6E-8101	A6E-8104	21.88
9	A6E-9101	A6E-9104	24.42
10	A6E-0101	A6E-0104	26.96

DIP Switch – A6E/A6ER

**DIP Terminal
Side Actuator (short-lever)**
A6ER-□101

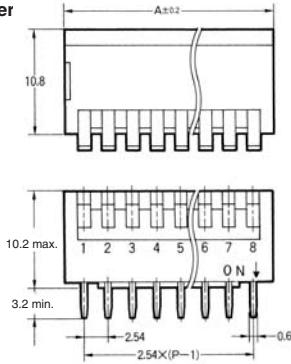
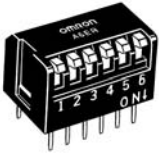

**Side Actuator
(long-lever)**

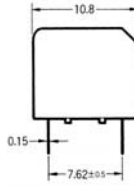

**Side Actuator
(short-lever)**

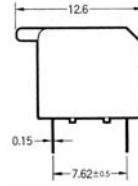

Side Actuator (long-lever)
A6E-□104

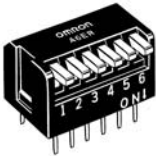

**PCB Dimensions
(Top View)**

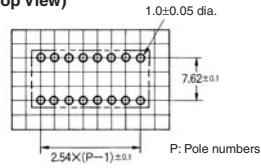

No. of poles	Model		Dimension A
2	A6E-2101	A6E-2104	6.64
3	A6E-3101	A6E-3104	9.18
4	A6E-4101	A6E-4104	11.72
5	A6E-5101	A6E-5104	14.26
6	A6E-6101	A6E-6104	16.80
7	A6E-7101	A6E-7104	19.34
8	A6E-8101	A6E-8104	21.88
9	A6E-9101	A6E-9104	24.42
10	A6E-0101	A6E-0104	26.96

Installation

■ Internal Connections (Top View)

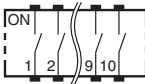

ALL DIMENSIONS SHOWN ARE IN MILLIMETRES.



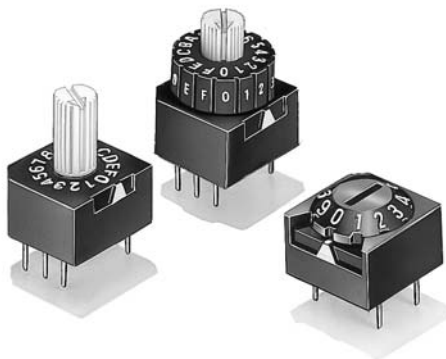

To convert millimetres into inches, multiply by 0.03937. To convert grams into ounces, multiply by 0.03527.

Select the Right Rotary DIP Switch for the Type of Operation

- ROHS compliant.
- Series includes a standard type that can be operated from the top or side, an extended shaft type that can be operated while mounted on a panel, and a flat type.
- A slider lock and rotating PCB system ensure stable contact reliability.
- Completely sealed construction prevents flux entry during automatic flow soldering.



Ordering Information

Type (rotor color)		Standard type (Black)	Flat type (White)	Extended shaft type (White)	Thumbwheel type (White)
		Appearance			
No. of Switching positions	Output code				
	10	BCD/hexadecimal 1-2-4-8 code	A6A-10R	A6A-10RF	A6A-10RS
BCD/hexadecimal 1-2-4-8 complement code		A6A-10C	A6A-10CF	A6A-10CS	A6A-10CW
16	BCD/hexadecimal 1-2-4-8 code	A6A-16R	A6A-16RF	A6A-16RS	A6A-16RW
	BCD/hexadecimal 1-2-4-8 complement code	A6A-16C	A6A-16CF	A6A-16CS	A6A-16CW

Note 1: Contact your OMRON sales representatives to request special markings or designations.

2: The standard packing configuration is units of 100 per box.

Specifications

■ Rating/Characteristics

Switching capacity	1 mA to 0.1 A at 5 to 28 VDC (switching current)
Ambient temperature	Operating: -10 to 70°C (no icing)
Ambient humidity	85% max.
Insulation resistance	10 MΩ min. (at 250 VDC)
Contact resistance	200 mΩ max. (initial value)
Dielectric strength	500 VAC at 50/60 Hz for 1min between ground and the charging plate 250 VAC at 50/60 Hz for 1min between terminals of the same polarity
Vibration resistance	Malfunction: 10 to 55 Hz, 1.5 mm double amplitude
Shock resistance	Malfunction: 300 m/s ² min.
Operating force	1.18 to 2.45 x 10 ⁻² N·m
Weight	Approx. 0.75g for the A6A-10R

■ 10-position Models

Position	Type	BCD/hexadecimal 1-2-4-8 code				BCD/hexadecimal 1-2-4-8 complement code			
	Terminal No.	1	2	3	4	5	6	7	8
0						•	•	•	•
1		•					•	•	•
2			•			•		•	•
3		•	•					•	•
4				•		•	•		•
5		•		•			•		•
6			•	•		•			•
7		•	•	•					•
8					•	•	•	•	
9		•			•		•	•	

■ 16-position Models

Position	Type	BCD/hexadecimal 1-2-4-8 code				BCD/hexadecimal 1-2-4-8 complement code			
	Terminal No.	1	2	3	4	5	6	7	8
0						•	•	•	•
1		•					•	•	•
2			•			•		•	•
3		•	•					•	•
4				•		•	•		•
5		•		•			•		•
6			•	•		•			•
7		•	•	•					•
8					•	•	•	•	
9		•			•		•	•	
A			•		•	•		•	
B		•	•		•			•	
C				•	•	•	•		
D		•		•	•		•		
E			•	•	•	•			
F		•	•	•	•				

Note: '•' indicates that the internal switch is ON.

DIP Switch (Rotary Type) – A6A

Dimensions

Note 1: All units are in millimetres unless otherwise indicated.

Standard Type, 10 Positions A6A-10R, A6A-10C

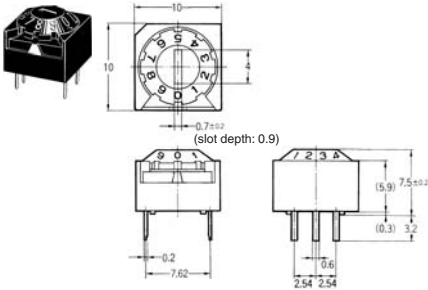

Standard Type, 16 Positions A6A-16R, A6A-16C

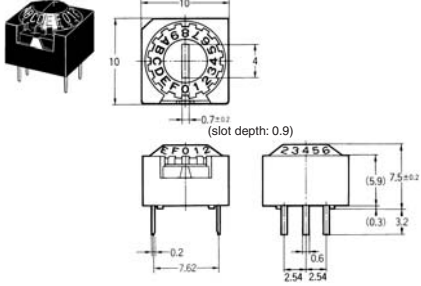

Flat Type, 10 Positions A6A-10RF, A6A-10CF

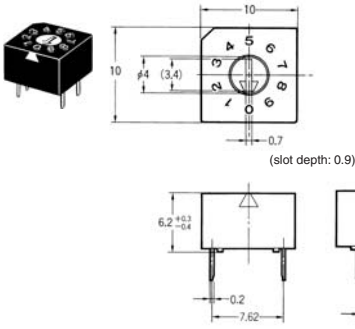

Flat Type, 16 Positions A6A-16RF, A6A-16CF

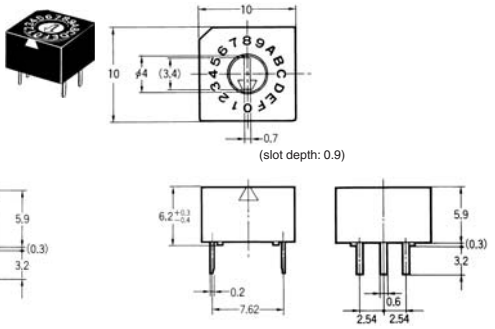

Extended Shaft Type, 10 Positions A6A-10RS, A6A-10CS

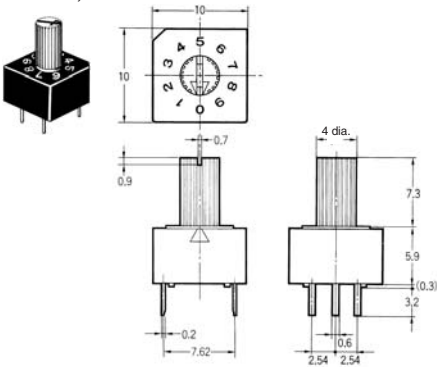

Extended Shaft Type, 16 Positions A6A-16RS, A6A-16CS

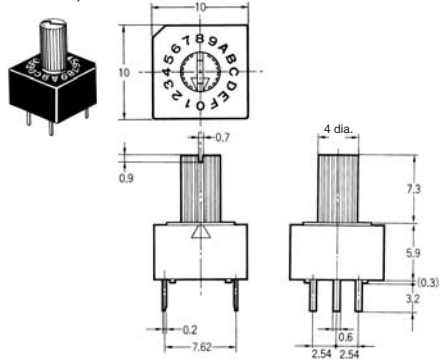

DIP Switch (Rotary Type) – A6A

Thumbwheel Type, 10 Positions A6A-10RW, A6A-10CW

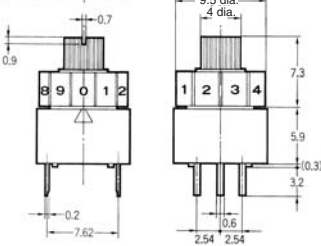
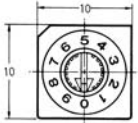

Thumbwheel Type, 16 Positions A6A-16RW, A6A-16CW

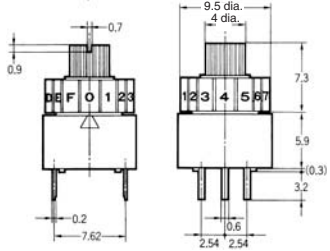
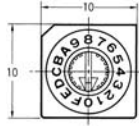

Installation

■ Internal Connections (Top View)

Terminal arrangement
(bottom view)

Mounting holes
(top view)

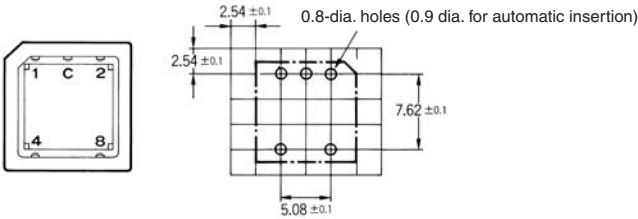

ALL DIMENSIONS SHOWN ARE IN MILLIMETRES.

To convert millimetres into inches, multiply by 0.03937. To convert grams into ounces, multiply by 0.03527.

Internally Sealed DIL-IC Type Rotary DIP Switch

- ROHS compliant.
- A precision rotary cam and contact driving mechanisms facilitate miniaturization.
- Reductions of 72% in height, 66% vertically, 90% horizontally and 43% in overall volume compared with the A6A allow for higher density mounting.
- Insert-molded terminals and an O-ring sealed rotor provide an airtight structure that keeps out dust, dirt and flux.
- Offset between terminal pins and side of case allows simple circuit inspection.

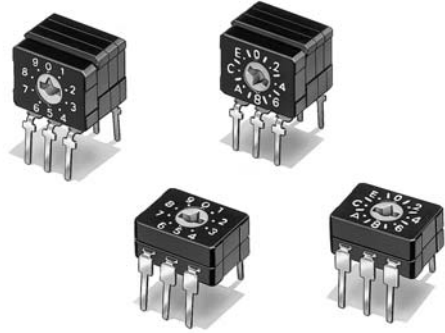

Ordering Information

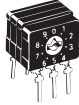
Type (rotor colour)		Top actuated type (Yellow)	Side actuated type (Yellow)
Appearance			
No. of Switching positions		Output code	
10	BCD/hexadecimal 1-2-4-8	A6C-10R (N)	A6CV-10R
16	BCD/hexadecimal 1-2-4-8	A6C-16R (N)	A6CV-16R

Note : A6Cs are packaged 55 units to a stick. A6CVs are packaged 100 to a box.

Specifications

Rating/Characteristics

Switching capacity	1 mA to 0.1 A (switching capacity) at 5 to 30 VDC Minimum permissible load of 10 mA (resistor load) at 3.5 VDC
Ambient temperature	Operating: -20 to 70°C (no icing)
Ambient humidity	35 to 95%
Insulation resistance	100 MΩ min. (at 250 VDC)
Contact resistance	200 mΩ max.
Dielectric strength	250 VAC for 1 minute between terminals of the same pole
Vibration resistance	Malfunction: 10 to 55 Hz, 1.5 mm double amplitude
Shock resistance	Malfunction: Approx. 300 m/s ²
Life expectancy	Mechanical: 10,000 operations min. Electrical: 2,000 operations min.
Operating torque	0.98 x 10 ⁻² N·m max.
Weight	A6C-10R (N): approx. 0.4 g A6CV-10R: approx. 0.7 g

Output Code Tables

■ 10-position Models

Type	A6C-10R, A6CV-10R			
Code	BCD/hexadecima* 1-2-4-8 code			
Position	1	2	3	4
0				
1	•			
2		•		
3	•	•		
4			•	
5	•		•	
6		•	•	
7	•	•	•	
8				•
9	•			•

■ 16-position Models

Type	A6C-16R, A6CV-16R			
Code	BCD/hexadecimal 1-2-4-8 code			
Position	1	2	3	4
0				
1	•			
2		•		
3	•	•		
4			•	
5	•		•	
6		•	•	
7	•	•	•	
8				•
9	•			•
A		•		•
B	•	•		•
C			•	•
D	•		•	•
E		•	•	•
F	•	•	•	•

Note: '•' in the above tables shows the output terminal No. that has continuity with the common terminal (C).

Dimensions

Note 1: All units are in millimetres unless otherwise indicated.

Top Actuated, 10 Positions A6C-10R (N)

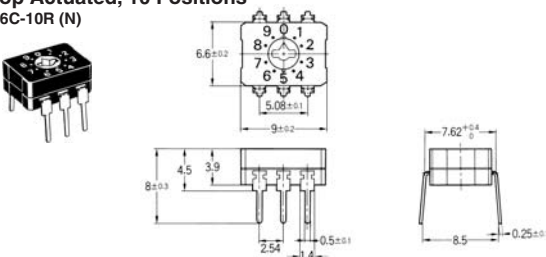

Terminal arrangement (top view)



Top Actuated, 16 Positions A6C-16R (N)

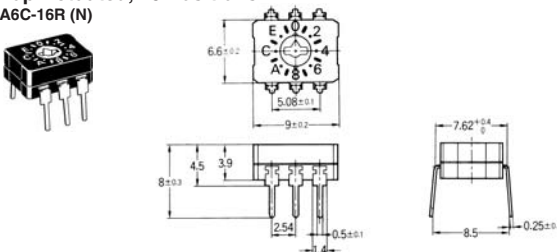

DIP Switch (Rotary Type) – A6C/A6CV

Side Actuated, 10 Positions A6CV-10R

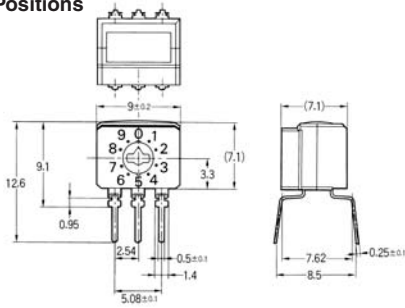

Terminal arrangement (top view)

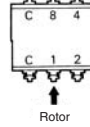

Side Actuated, 16 Positions A6CV-16R

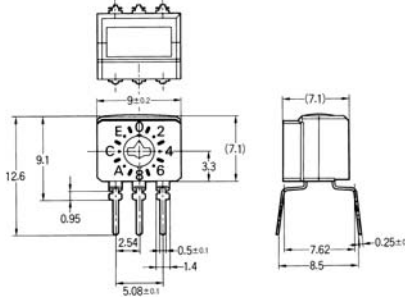
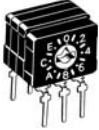

Installation

■ Internal Connections (Top View)

Internal connections (top view)

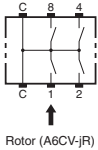

Mounting holes (top view)

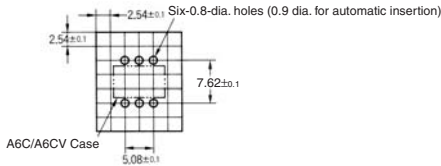

ALL DIMENSIONS SHOWN ARE IN MILLIMETRES.

To convert millimetres into inches, multiply by 0.03937. To convert grams into ounces, multiply by 0.03527.

DIP Switch (Rotary Type) – A6R/A6RV

Low-cost Rotary DIP Switches

- ROHS compliant.
- Series includes top-actuated, side-actuated, flat, and extended-shaft models.
- The rotor has an O-ring sealed construction that prevents the ingress of dirt and dust.
- Two different types of terminal arrangement are available for each model to allow flexibility in the circuit design.

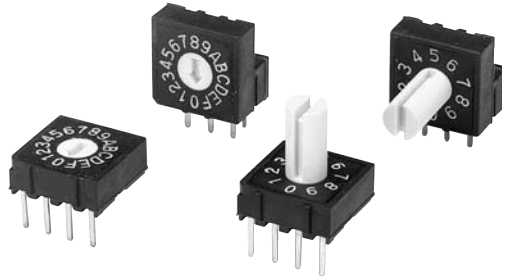

Ordering Information

List of Models

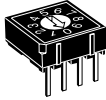
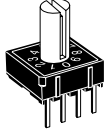
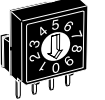
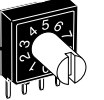
				Type	Top-actuated, flat (White)	Top-actuated, extended shaft	Side-actuated, flat (White)	Side-actuated, extended shaft
Appearance								
No. of Positions	Quantity per stick	Terminal Arrangement	Output Code					
10	48	4 x 1	Real code	A6R-101RF	A6R-101RS	A6RV-101RF	A6RV-101RS	
		3 x 3	Real code	A6R-102RF	A6R-102RS	A6RV-102RF	A6RV-102RS	
16	48	4 x 1	Real code	A6R-161RF	A6R-161RS	A6RV-161RF	A6RV-161RS	
		3 x 3	Real code	A6R-162RF	A6R-162RS	A6RV-162RF	A6RV-162RS	

Note: Switches are delivered in units of 48. Orders must be made in multiples of 48.

Specifications

Rating/Characteristics

Rating	25 mA at 24 VDC
Ambient operating temperature	-25 to 80°C (with no icing or condensation)
Ambient operating humidity	35% to 95%
Insulation resistance	100 MΩ min. (at 250 VDC)
Contact resistance	200 mΩ max. (initial value)
Dielectric strength	250 VAC for 1 minute between terminals of the same polarity
Vibration resistance	Malfunction: 10 to 55 Hz, 1.5-mm double amplitude
Shock resistance	Malfunction: Approx. 300 m/s ²
Electrical life expectancy	5,000 steps min.
Operating torque	1.96 x 10 ⁻² N·m max.
Weight	4x1, top-actuated: 0.64 g 3x3, top-actuated: 0.62 g 4x1, side-actuated: 0.8 g 3x3, side-actuated: 0.83 g (Add 0.13 g for the extended-shaft version of each model.)

Output Code Tables

■ 10-position Models

Code	Real Code			
	1	2	3	4
0				
1	•			
2		•		
3	•	•		
4			•	
5	•		•	
6		•	•	
7	•	•	•	
8				•
9	•			•

■ 16-position Models

Code	Real Code			
	1	2	3	4
0				
1	•			
2		•		
3	•	•		
4			•	
5	•		•	
6		•	•	
7	•	•	•	
8				•
9	•			•
A		•		•
B	•	•		•
C			•	•
D	•		•	•
E		•	•	•
F	•	•	•	•

Note: '•' indicates that the internal switch is ON.

Dimensions

Note: 1. All units are in millimetres unless otherwise indicated.

2. A tolerance of ± 0.4 mm applies to the above dimensions unless otherwise specified.

Top-actuated Flat Models with 4x1 Terminal Arrangement

A6R-101RF

A6R-161RF

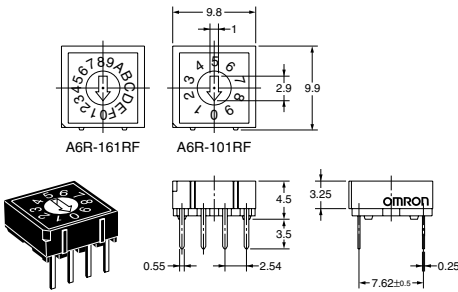

Top-actuated Extended-shaft Models with 4x1 Terminal Arrangement

A6R-101RS

A6R-161RS

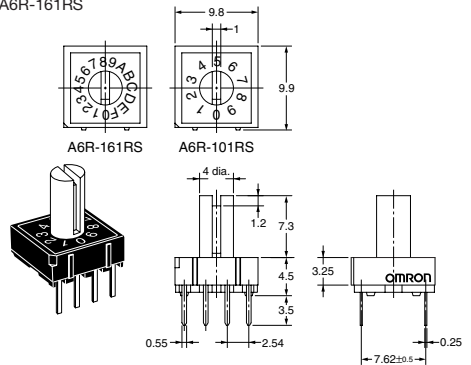

DIP Switch (Rotary Type) – A6R/A6RV

Top-actuated Flat Models with 3x3 Terminal Arrangement

A6R-102RF
A6R-162RF

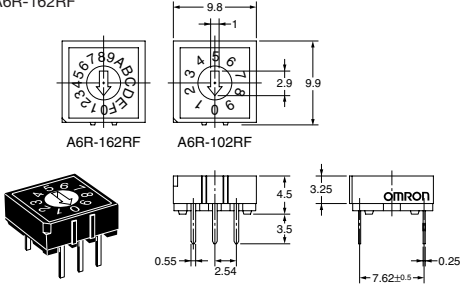

Top-actuated Extended-shaft Models with 3x3 Terminal Arrangement

A6R-102RS
A6R-162RS

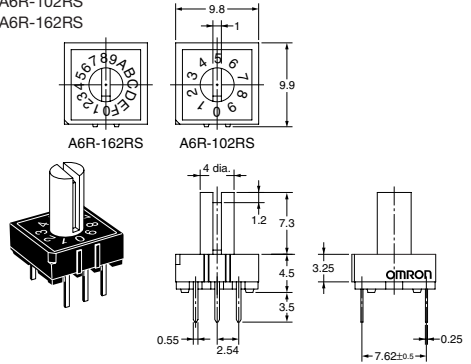

Side-actuated Flat Models with 4x1 Terminal Arrangement

A6RV-101RF
A6RV-161RF

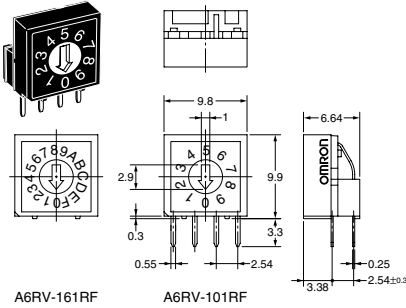

Side-actuated Extended-shaft Models with 4x1 Terminal Arrangement

A6RV-101RS
A6RV-161RS

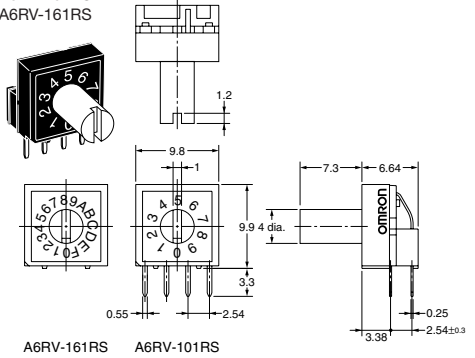

Side-actuated Flat Models with 3x3 Terminal Arrangement

A6RV-102RF
A6RV-162RF

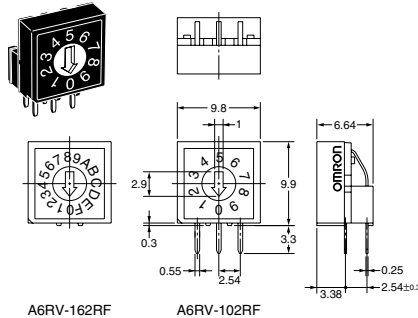

Side-actuated Extended-shaft Models with 3x3 Terminal Arrangement

A6RV-102RS
A6RV-162RS

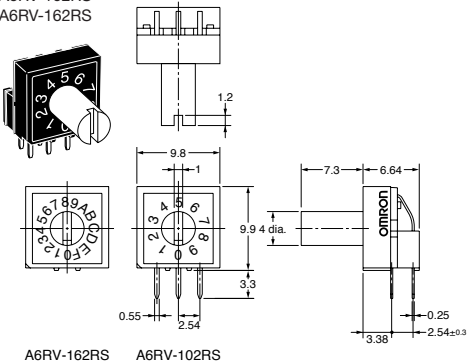

DIP Switch (Rotary Type) – A6R/A6RV

■ PCB Cutout Dimensions

Top-actuated Models

4x1 Terminal Arrangement

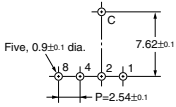

3x3 Terminal Arrangement

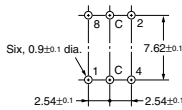

Side-actuated Models

4x1 Terminal Arrangement

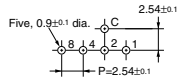

3x3 Terminal Arrangement

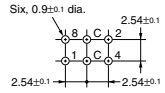

ALL DIMENSIONS SHOWN ARE IN MILLIMETRES.

To convert millimetres into inches, multiply by 0.03937. To convert grams into ounces, multiply by 0.03527.