

■ Glossary

CONTACTS

Contact Form

The contact mechanism of the Relay.

Number of Contact Poles

The number of contact circuits.

Rated Load

The rated load of the contact of the Relay, which determines the characteristic performance of the contact of the Relay, is expressed by the switching voltage and switching current.

Maximum Switching Voltage

The switching voltage of the Relay determines the characteristic performance of the contact of the Relay. Do not apply voltage that exceeds the maximum switching voltage of the Relay.

Carry Current

The value of the current which can be continuously applied to the Relay contacts without opening or closing them, which also allows the Relay to stay within the permissible temperature rise limit.

Maximum Switching (Contact) Current

A current which serves as a reference in determining the performance of the Relay contacts. This value will never exceed the carry current. When using a Relay, plan not to exceed this value.

Contact Resistance

The total resistance of the conductor, which includes specific resistivities, such as of the armature and terminal, and the resistance of the contacts. This value is determined by measuring the voltage drop across the contacts by the allowed test current shown in the table below.

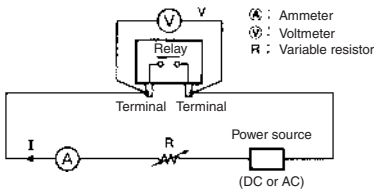

Test Current

Rated current or switched current (A)	Test current (mA)
0.01 or higher but less than 0.1	10
0.1 or higher but less than 1	100
1 or higher	1,000

To measure the contact resistance, a milliohmmeter can also be used, although the accuracy drops slightly.

Contact Symbols

NO contact	NC contact	SPDT contact
Double-break NO contact	Double-break NC contact	Make-before-contact contact
Wiper contact	Latching Relay contact	Ratchet relay contact

Make-before-break Contact

A contact arrangement in which part of the switching section is shared between both an NO and an NC contact. When the Relay operates or releases, the contact that closes the circuit operates before the contact that opens the circuit releases. Thus both the contacts are closed momentarily at the same time.

Maximum Switching Power

The maximum capacity value of the load which can be switched without causing problems of material break-down and/or electrical overload. When using a Relay, be careful not to exceed this value. For example, when switching voltage V_1 is known, max. switching current I_1 can be obtained at the point of intersection on the characteristic curve "Maximum switching power" below. Conversely, max. switching voltage V_1 can be operated if I_1 is known.

Max. switching current (I_1) =

$$\frac{\text{Maximum switching power [W(VA)]}}{\text{Switching voltage (V}_1\text{)}}$$

Switching voltage (V_1)

For instance, if the switching voltage = 40 V, the max. switching current = 2 A (see circled point on graph).

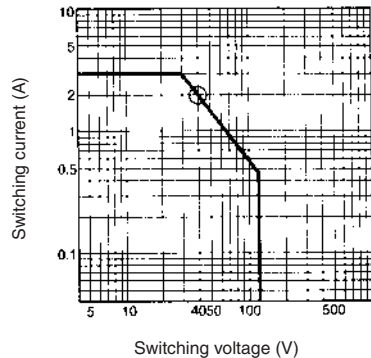

Electrical Endurance

The electrical endurance of the Relay can be determined from the “Electrical life” curve shown below, based on the rated switching current (I_1) obtained above.

For instance, the electrical endurance for the max. switching current of 2 A is slightly over 300,000 operations (see circled point on graph below).

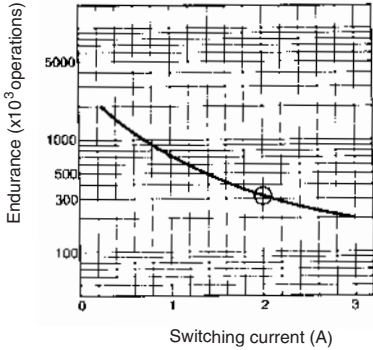

However, with a DC load, it may become difficult to break a circuit of 48 V or more, due to arcing. Determine suitability of the Relay in actual usage testing. Correlation between the contact ratings is as shown below.

Coil

Single-stable		Double-winding		Single-winding latching
With pole	Without pole	4 terminals	3 terminals	

Coil Current (Applicable to AC-switching Type Only)

A current which flows through the coil when the rated voltage is applied to the coil at a temperature of 23°C. The tolerance is +15%, -20% unless otherwise specified.

Maximum Switching Power

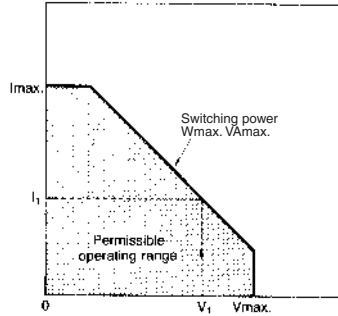

Failure Rate

The failure rate indicates the lower limit of the switching power of a Relay. Such minute load levels are found in microelectronic circuits. This value may vary, depending on operating frequency, operating conditions, expected reliability level of the Relay, etc. It is always recommended to double-check Relay suitability under actual load conditions.

In this catalog, the failure rate of each Relay is indicated as a reference value. It indicates error level at a reliability level of 60% (λ_{60}).

$\lambda_{60} = 0.1 \times 10^{-6}/\text{operation}$ means that one error is presumed to occur per 10,000,000 operations at the reliability level of 60%.

Coil Voltage

A reference voltage applied to the coil when the Relay is used under the normal operation conditions. The following table lists the 100/110 VAC voltages

Applicable power source	Inscription on Relay	Denomination in catalog
100 V 50 Hz	100 VAC 60 Hz	100 VAC 60 Hz
100 VAC 50 Hz 100 VAC 60 Hz	100 VAC	100 VAC
100 VAC 50 Hz 100 VAC 60 Hz 100 VAC 60 Hz	100/110 VAC 60 Hz 100 VAC 50 Hz	100/(110) VAC
100 VAC 50 Hz 100 VAC 60 Hz 110 VAC 50 Hz 110 VAC 60 Hz	100/110 VAC	100/110 VAC

Power Consumption

The power (=rated voltage x rated current) consumed by the coil when the rated voltage is applied to it. A frequency of 60 Hz is assumed if the Relay is intended for AC operation.

The current flows through the coil when the rated voltage is applied to the coil at a temperature of 23°C and with a tolerance of +15% and -20% unless otherwise specified.

Coil Resistance (Applicable to DC-switching Type Only)

The resistance of the coil measured at a temperature of 23°C with a tolerance of ±10% unless otherwise specified. (The coil resistance of an AC-switching Relay may be given for reference when the coil inductance is specified.)

Must-release (Must-reset) Voltage

The threshold value of a voltage at which a Relay releases when the rated input voltage applied to the Relay coil in the operating state is decreased gradually.

Must-operate (Must-set) Voltage

The threshold value of a voltage at which a Relay operates when the input voltage applied to the Relay coil in the reset state is increased gradually.

Example: MY4 DC Models

The distributions of the must-operate voltage and the must-release voltage are shown in the following graph.

As shown in the graph, the Relay operates at voltages less than 80% of the rated voltage and releases at voltages greater than 10% of the rated voltage. Therefore, in this catalog, the must-operate and must-release voltages are taken to be 80% max. and 10% min. respectively of the rated voltage.

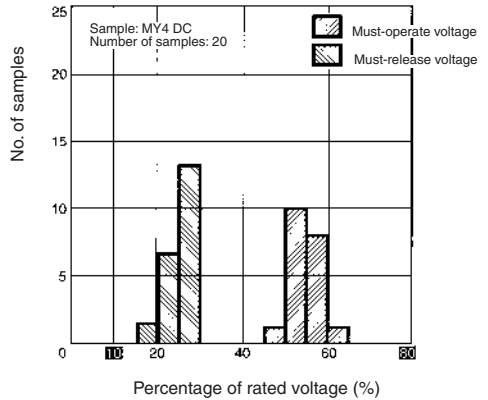

Hot Start

The ratings set forth in the catalog or data sheet are measured at a coil temperature of 23°C unless otherwise specified. However, some catalogs have the description "Hot start 85% (at Ta = 40°C)". This means that the must-operate voltage when the Relay is operated after the rated current is consecutively applied to the coil at an ambient temperature of 40°C satisfies a maximum of 85% of the rated must-operate voltage.

Maximum Switching Voltage

The maximum value (or peak value, not continuous value) of permissible voltage fluctuations in the operating power supply of the Relay coil.

Minimum Pulse Width

The minimum width of the pulsating voltage required to set and reset a Latching Relay at a temperature of 23°C.

Coil Inductance

With DC Relays, the coil inductance is obtained by adding the square waveform to a time constant. With AC Relays, it is the value at the rated frequency. In both cases, the values will be different depending on whether the Relay is in the set or the reset condition.

ELECTRICAL CHARACTERISTICS

Mechanical Life Expectancy

The life of a Relay when it is switched at the rated operating frequency, but without the rated load.

Electrical Endurance

The life of a Relay when it is switched at the rated operating frequency, with the rated load applied to its constants.

Bounce

Bouncing is the intermittent opening and closing between contacts caused by vibration or shock resulting from collision between the Relay's moving parts (poles and terminals) and the iron core and backstop, and collision between contacts.

Operate Bounce Time

The bounce time of the normally open (NO) contact of a Relay when the rated coil voltage is applied to the Relay coil, at an ambient temperature of 23°C.

Operate Time

The time that elapses after power is applied to a Relay coil until the NO contacts have closed, at an ambient temperature of 23°C. Bounce time is not included. For the Relays having an operate time of less than 10 ms, the mean (reference) value of its operate time is specified as follows:

Operate time	5 ms max. (mean value: approx. 2.3 ms)
---------------------	--

Release Bounce Time

The bounce time of the normally closed (NC) contact of a Relay when the coil is deenergized at an ambient temperature of 23°C.

Release Time

The time that elapses between the moment a Relay coil is deenergized until the NC contacts have closed, at an ambient temperature of 23°C. (With a Relay having SPST-NO or DPST-NO contacts, this is the time that elapses until the NO contacts have operated under the same condition.) Bounce time is not included. For Relays having a release time of less than 10 ms, the mean (reference) value of its release time is specified as follows:

Release time	5 ms max. (mean value: approx. 2.3 ms)
---------------------	--

Reset Time (Applicable to Latching Relays Only)

The time that elapses from the moment a Relay coil is deenergized until the NC contacts have closed, at an ambient temperature of 23°C. (With a Relay having SPST-NO or DPST-NO contacts, this is the time that elapses until the NO contacts have operated under the same condition.) Bounce time is not included. For Relays having an operate time of less than 10 ms, the mean (reference) value of its operate time is specified as follows:

Reset time	5 ms max. (mean value: approx. 2.3 ms)
-------------------	--

Set Time (Applicable to Latching Relays Only)

The time that elapses after power is applied to a Relay coil until the NO contacts have closed, at an ambient temperature of 23°C. Bounce time is not included. For the Relays having an operate time of less than 10 ms, the mean (reference) value of its operate time is specified as follows:

Set time	5 ms max. (mean value: approx. 2.3 ms)
-----------------	--

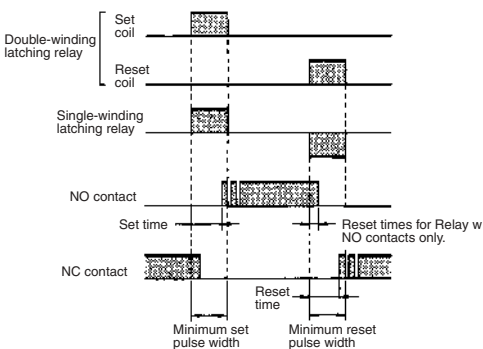

Dielectric Strength

The critical value which a dielectric can withstand without rupturing, when a high-tension voltage is applied for 1 minute between the following points:

- Between coil and contact
- Between contacts of different polarity
- Between contacts of same polarity
- Between set coil and reset coil
- Between current-carrying metal parts and ground terminal

Note that normally a leakage current of 3 mA is detected; however, a leakage current of 1 mA or 10 mA may be detected on occasion.

Impulse Withstand Voltage

The critical value which the Relay can withstand when the voltage surges momentarily due to lightning, switching an inductive load, etc. The surge waveform which has a pulse width of +1.2 x 50 ms is shown below:

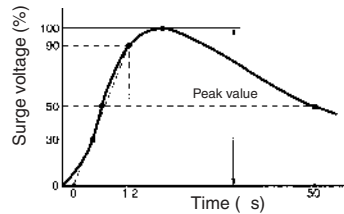

Insulation Resistance

The resistance between an electric circuit (such as the contacts and coil), and grounded, non-conductive metal parts (such as the core), or the resistance between the contacts. The measured values are as follows

Rated insulation voltage	Measured value
60 V max.	250 V
61 V min.	500 V

Switching Frequency

The frequency or intervals at which the Relay continuously operates and releases, satisfying the rated mechanical and electrical service lives.

Shock Resistance

The shock resistance of a Relay is divided into two categories: Destruction, which quantifies the characteristic change of, or damage to, the Relay due to considerably large shocks which may develop during the transportation or mounting of the Relay, and malfunction durability, which quantifies the malfunction of the Relay while it is in operation.

Stray Capacitance

The capacitance measured between terminals at an ambient temperature of 23°C and a frequency of 1 kHz.

Vibration Resistance

The vibration resistance of a Relay is divided into two categories: Destruction, which quantifies the characteristic changes of, or damage to, the Relay due to considerably large vibrations which may develop during the transportation or mounting of the Relay, and Malfunction durability, which quantifies the malfunction of the Relay due to vibrations while it is in operation.

$$\alpha = 0.002f^2A$$

α : Acceleration of vibration

f: Frequency

A: Double amplitude

OPERATING

Single Stable Relays (Standard Type)

These are Relays in which the contacts switch in response to the energization and deenergization of the coil and do not have any special functions.

**Terminal Arrangement/Internal Connections
(Bottom view)**

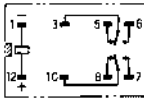

Double-winding Latching Relays

These are Relays that have a set coil and a reset coil, and have a latching mechanism enabling the set or reset condition to be locked.

**Terminal Arrangement/Internal Connections
(Bottom view)**

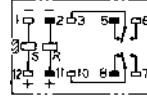

S: set coil
R: reset coil

Single-winding Latching Relays

These are Relays that have one coil, and switch between the set and reset condition according to the polarity of the applied voltage, and have a latching mechanism enabling this status to be locked.

**Terminal Arrangement/Internal Connections
(Bottom view)**

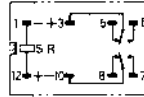

S: set coil
R: reset coil

Stepping Relays

These are Relays in which the contacts shift ON or OFF sequentially with each coil input pulse.

Ratchet Relays

These are Relays in which the contacts alternately turn ON and OFF, or sequentially operate, when a pulse signal is input.

Precautions

General handling

- To maintain initial performance, be careful not to drop the Relay or subject it to shock.
- The case is so constructed that it will not come off with normal handling. To maintain initial performance, do not allow the case to come off.
- Use the Relay in a dry atmosphere containing little dust, SO₂, H₂S, and organic gases.
- Ensure that the voltage applied to the coil is not applied continuously in excess of the maximum permissible voltage.
- With DC-operated Relays that have a built-in diode or a built-in operation indication lamp, do not reverse the polarity connections when the polarity of the coil is specified.
- Do not use the Relay at a voltage or current greater than the specified values.
- Ensure that the ambient operating temperature does not exceed the specified value.
- With General-purpose Relays, leaving or using the Relay for a long time in an atmosphere of hydrogen sulfide gas or high temperature and high humidity will lead to the formation of a sulfide film or an oxidation film on the surface of the contact. In Miniature Relays, the contact force is weak and so the film cannot be destroyed mechanically. Also, with the very small loads, destruction of the film is not possible by arcing and so there will be contact instability and the occurrence of problems in performance and function. For these reasons, Fully Sealed Relays or Hermetically Sealed Relays should be used in atmospheres of harmful gases (such as H₂S, SO₂, NH₃, and Cl₂), humidity, and dust.
- The contact ratings of Relays approved by standards and the general ratings of the Relays could be different.

When combining Relays with various types of Sockets, check the contact ratings of the Relays before use.

OPERATING COILS

AC-operated Relays

The power supply used to operate AC-operated Relays is almost always at the commercial frequency (50 or 60 Hz). Standard voltages are 6, 12, 24, 48, 100, and 200 VAC. Because of this, when the voltage is other than a standard voltage, the Relay will be a special-order item and so inconvenience may arise with respect to price, delivery period, and stability of performance. Consequently, a Standard-voltage Relay should be selected if at all possible.

In AC-operated Relays, there is a resistance loss of the shading coil, an overcurrent loss of the magnetic circuit, a hysteresis loss, as well as other losses. The coil input also increases and so in general it is normal for the temperature rise to be higher than in a DC-operated Relay. Also, at voltages less than the must-operate voltage (i.e., the minimum operation voltage), a vibration is produced which necessitates that attention be paid to the fluctuation of the power supply voltage.

For example, when the power supply voltage drops at the time of motor starting, the Relay will be reset while vibrating and the contacts will burn, fuse, or the self holding will go out of place. In AC-operated Relays, there is an inrush current. (When the armature is in a separated condition, the impedance is low and a current flows that is larger than the rated current; when the armature is in the closed condition, the impedance increases and a current flows which is of the rated value.) When a large number of Relays are used connected in series, this factor must be taken into account together with the power consumption.

DC-operated Relays

The power supply used to operate DC-operated Relays may have voltage as a standard or it may have current as a standard. When voltage is the standard, the rated coil voltages include 5, 6, 12, 24, 48, and 100 VDC. When current is the standard, the rated current in mA is listed in the catalog.

In DC-operated Relays, when the Relay is used in an application where it is operated at some limit value, either voltage or current, the current applied to the coil will gradually increase or decrease. It is important to note that this may delay the movement of the contacts resulting in failure to meet the specified control capacity. The coil resistance value of a DC-operated Relay may change by approximately 0.4% per °C due to changes in the ambient temperature and the heat radiated by the Relay itself. Therefore, it is important to note that increases in temperature will be accompanied by higher must-operate and must-release voltages.

Power Supply Capacity

The fluctuation of the power supply voltage over a long period will of course affect Relay operation, but momentary fluctuations will also be the cause of incorrect Relay operation.

For example, when a large solenoid, Relay, motor, heater, or other device is operated from the same power supply as the one that operates the Relay, or when a large number of Relays are used, if the power supply does not have sufficient capacity when these devices are operated simultaneously, the voltage drop may prevent the Relay from operating. On the other hand, when the voltage drop is estimated and the voltage increased accordingly, if the voltage is applied to the Relay when there is no voltage drop, this will cause heating of the coil.

Provide leeway in the capacity of the power supply and keep the voltage within the switching voltage range of the Relay.

Lower Limit Value of the Must-operate Voltage

Use of Relays at high temperatures or rise of coil temperature due to a continuous flow of current through the coil will result in an increase in coil resistance which means the must-operate voltage will also increase. This matter requires attention be paid to determining a lower limit value of the operation power supply voltage. The following example and explanation should be referred to when designing the power supply.

Note: Even though the rating is a voltage rating (as is the rating for all Standard Relays), the Relay should be thought of as being current operated.

Catalog values for model MY

Rated voltage: 24 VDC, coil resistance: 650 Ω, must-operate voltage: 80% or less of rated voltage, at a coil temperature of 23°C.

A rated current of 36.9 mA (24 VDC/650 W = 36.9 mA) flows through this Relay, which operates at 80% or less of this value i.e., at 29.5 mA or less (36.9 mA x 0.8 = 29.5 mA). When the present coil temperature rises by 10°C, the coil resistance will be 676 W (650 Ω x 1.04 = 676 W). To have the must-operate current of 29.5 mA flow in this condition, it will be necessary to apply a voltage of 19.94 V (29.5 mA x 676 Ω = 19.94 v). This voltage (which is the must-operate voltage when the coil temperature is 33°C (23°C + 10°C), is 83.1% (19.94/24 = 83.1%) of the rated voltage which represents an increase compared to when the coil temperature was 23°C.

Classification		Control Panel Relay							
Model		MY – New model				LY			
Features		Versatile relay, ideal for power and sequence control applications, meets many other application requirements.				Compact, general-purpose 15-A and 10-A relays ideal for many applications.			
Appearance									
Contact Ratings	Contact Form	DPDT		4PDT		SPDT	DPDT	3PDT	4PDT
	Mechanism	Single		Single	Bifurcated	Single		Bifurcated	Single
	Material	Ag		Au-clad+Ag		Ag-alloy		Ag	Ag-alloy
	Rated Load* (Resistive load)	5 A at 250 VAC/ 30 VDC		3 A at 250 VAC/ 30 VDC		15 A at 110 VAC/ 24 VDC	10 A at 110 VAC/ 24 VDC	5 A at 110 VAC/ 24 VDC	10 A at 110 VAC/ 24 VDC
	Max. Switching Current	10 A		5 A		15 A	10 A	7 A	10 A
	Failure rate (mA) (reference value)	1 mA at 5 VDC		1 mA at 1 VDC	100 µA at 1 VDC	100 mA at 5 VDC		10 mA at 5 VDC	100 mA at 5 VDC
Coil ratings	Rated Voltage	6 to 100/110 VDC 6 to 220/240 VAC				6 to 100/110 VDC 6 to 220/240 VAC			
	Power Consumption (approx.)	0.9 W (DC) 0.9 to 1.2 VA (AC)				0.9 W (DC) 0.9 to 1.2 VA (AC)		1.4 W (DC) 1.6 to 2.0 VA (AC)	1.5 W (DC) 1.95 to 2.5 VA (AC)
Endurance	Mechanical	50,000,000 (AC), 100,000,000 (DC)			20,000,000	50,000,000 (AC), 100,000,000 (DC)			
	Electrical	500,000	200,000	100,000	200,000	500,000	200,000		
Dielectric strength	Between coil and contacts	2,000 VAC for 1 min.				2,000 VAC for 1 min.			
	Between contacts of different polarity	2,000 VAC for 1 min.				–	2,000 VAC for 1 min.		
	Between contacts of same polarity	1,000 VAC for 1 min.				1,000 VAC for 1 min.			
	Between set and reset coils	–				–			
Ambient temperature (operating)		–55°C to 70°C				–25°C to 55°C		–25°C to 40°C	
Functions		<ul style="list-style-type: none"> Mechanical indicator LED indicator Built-in diode 		<ul style="list-style-type: none"> Test button Arc barriers Built-in CR 		<ul style="list-style-type: none"> LED indicator Built-in diode Built-in CR 		<ul style="list-style-type: none"> Test button 	
Sealing		Cased (unsealed)				Cased (unsealed)			
Technical Construction**		(ask sales office)							
Approved Standards									
Page		487				500			





* Numbers in parentheses apply to cased (unsealed) types.

** denotes PCB terminal, plug-in (octal-pin) terminal, plug-in/solder terminal, quick-connect terminal, and screw terminal.

Classification		Control Panel Relay		Built-in Relay		
Model		G2RS		G7L		
Features		Reliable and unique test button models now available. High switching power (1 pole: 10 A). Highly functional socket also available. Environmentally friendly.		Multi-pole power relay that withstands a momentary voltage drop. Wide range of applications with 100-V and 200-V coils. Both screw terminals and PCB terminals are available.		
Appearance						
Contact Ratings	Contact Form	SPDT	DPDT	SPST-NO	DPST-NO	SPST-NO, DPST-NO
	Mechanism	Single	Single	Double-break		
	Material	Ag-alloy		Ag-alloy		
	Rated Load* (Resistive load)	10A at 250 VAC/ 30 VDC	5A at 250 VAC/ 30 VDC	30 A at 220 VAC	25 A at 220 VAC	20 A at 220 VAC
	Max. Switching Current	10 A	5 A	30 A	25 A	20 A
	Failure rate (mA) (reference value)	100 mA at 5 VDC	10 mA at 5 VDC	100 mA at 5 VDC		
Coil ratings	Rated Voltage	6 to 48 VDC 24 to 240 VAC		6 to 100 VDC 12 to 200/240 VAC		
	Power Consumption (approx.)	0.53 W (DC) 0.9 VA (AC)		1.9 W (DC) 1.7 to 2.5 VA (AC)		
Endurance	Mechanical	10,000,000 (AC), 20,000,000 (DC)		1,000,000		
	Electrical	100,000		100,000		
Dielectric strength	Between coil and contacts	5,000 VAC for 1 min.		4,000 VAC for 1 min.		
	Between contacts of different polarity	–	3,000 VAC for 1 min.	–	2,000 VAC for 1 min. (DPST-NO only)	
	Between contacts of same polarity	1,000 VAC for 1 min.		2,000 VAC for 1 min.		
	Between set and reset coils	–	–	–		
Ambient temperature (operating)		–40°C to 70°C		–25°C to 60°C		
Functions		<ul style="list-style-type: none"> LED indicator Test button Built-in diode 		<ul style="list-style-type: none"> Test button (excluding P models) 		
Sealing		Cased (unsealed)		Cased (unsealed)		
Technical Construction**						
Approved Standards						
Page		513		523		

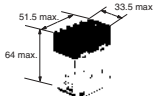
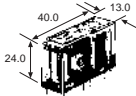
* Numbers in parentheses apply to cased (unsealed) types.

** denotes PCB terminal, plug-in (octal-pin) terminal, plug-in/solder terminal, quick-connect terminal, and screw terminal.

Classification		Built-in Relay	Built-in Relay
Model		G7J	G7SA
Features		Multi-pole power relay that withstands a momentary voltage drop. Wide range of applications with 100-V and 200-V coils. Both screw terminals and PCB terminals are available.	Safety relay that conforms to EN standard. Forcibly guided contacts (En50205 Class A). Suitable for safety circuits in press machinery, machine tools and other production machinery
Appearance			
Contact Ratings	Contact Form	4PST-NO, 3PST-NO/SPST-NC, DPST-NO/DPST-NC	4PST-NO/DPST-NC, 3PST-NO/3PST-NC
	Mechanism	Double-break	Single
	Material	Ag-alloy	Ag + Au plating
	Rated Load* (Resistive load)	25 A at 220 VAC, 100,000 operations min. 25 A at 30 VDC, 100,000 operations min. (For normally closed contacts, 8 A at 220 VAC, 8 A at 30 VDC)	3 A at 240 VAC/24VDC, 100,000 operations min
	Max. Switching Current	25 A	6 A
	Failure rate (mA) (reference value)	100 mA at 24 VDC	10 mA at 5 VDC
Coil ratings	Rated Voltage	12 to 100 VDC 24 to 200/240 VAC	24 VDC
	Power Consumption	Approx. 2 W (DC) Approx. 1.8 to 2.6 VA (AC)	0.8 W
Endurance	Mechanical	1,000,000	10,000,000
	Electrical	100,000	100,000
Dielectric strength	Between coil and contacts	4,000 VAC for 1 min.	2,500 VAC for 1 min.
	Between contacts of different polarity	4,000 VAC for 1 min.	2,500 VAC for 1 min.
	Between contacts of same polarity	2,000 VAC for 1 min.	1,500 VAC for 1 min.
	Between set and reset coils	–	–
Ambient temperature (operating)		–25°C to 60°C	–40°C to 85°C
Functions		• With test button	• Forced guided contacts
Sealing		Cased	Cased
Technical Construction**			
Approved Standards			
Page		538	557

* Numbers in parentheses apply to cased (unsealed) types.

**  denotes PCB terminal,  plug-in (octal-pin) terminal,  plug-in/solder terminal,  quick-connect terminal, and  screw terminal.

**Versatile and Function-filled
Miniature Power Relay for Sequence
Control and Power Switching
Applications**



- Many variations possible through a selection of operation indicators (mechanical and LED indicators), test button, built-in diode and CR (surge suppression), bifurcated contacts, etc.
- Arc barrier standard on 4-pole Relays.
- Dielectric strength: 2,000 VAC (coil to contact)
- Environment-friendly cadmium-free contacts.
- Safety standard approvals obtained.
- Wide range of Sockets (PY, PYF Series) and optional parts are available.
- Max. Switching Current: 2-pole: 10 A, 4-pole: 5 A
- Built-in mechanical operation indicator.
- Provided with nameplate.

Ordering Information

■ **Relays**

Standard Coil Polarity

Type	Contact form	Plug-in socket/Solder terminals		Without LED indicator
		Standard with LED indicator	With LED indicator and test button	
Standard	DPDT	MY2N	MY2IN	MY2
	4PDT	MY4N	MY4IN	MY4
	4PDT (bifurcated)	MY4ZN	MY4ZIN	MY4Z
With built-in diode (DC only)	DPDT	MY2N-D2	MY2IN-D2	-
	4PDT	MY4N-D2	MY4IN-D2	-
	4PDT (bifurcated)	MY4ZN-D2	MY4ZIN-D2	-
With built-in CR (220/240 VAC, 110/120 VAC only)	DPDT	MY2N-CR	MY2IN-CR	-
	4PDT	MY4N-CR	MY4IN-CR	-
	4PDT (bifurcated)	MY4ZN-CR	MY4ZIN-CR	-

Reverse Coil Polarity

Type	Contact form	Plug-in socket/Solder terminals	
		With LED indicator	With LED indicator and test button
Standard (DC only)	DPDT	MY2N1	MY2IN1
	4PDT	MY4N1	MY4IN1
	4PDT (bifurcated)	MY4ZN1	MY4ZIN1
With built-in diode (DC only)	DPDT	MY2N1-D2	MY2IN1-D2
	4PDT	MY4N1-D2	MY4IN1-D2
	4PDT (bifurcated)	MY4ZN1-D2	MY4ZIN1-D2

Note: When ordering, add the rated coil voltage and "(s)" to the model number. Rated coil voltages are given in the coil ratings table.

Example: MY2 6VAC (S)

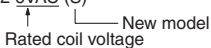

■ Accessories (Order Separately)

Sockets

Poles	Front-mounting Socket (DIN-track/screw mounting)	Back-mounting Socket				PCB terminals
		Solder terminals		Wire-wrap Terminals		
		Without clip	With clip	Without clip	With clip	
2	PYF08A-E PYF08A-N	PY08	PY08-Y1	PY08QN PYF08QN2	PY08QN-Y1 PY08QN2-Y1	PY08-02
4	PYF14A-E PYF14A-N	PY14	PY14-Y1	PY14QN PY14QN2	PY14QN2-Y1 PY14QN-Y1	PY14-02

Socket Hold-down Clip Pairing

Relay Type	Poles	Front-connecting Socket (DIN-track/screw mounting)		Back-connecting Socket			
		Socket	Clip	Solder/Wire-wrap terminals		PCB terminals	
				Socket	Clip	Socket	Clip
Without 2-pole test button	2	PYF08A-E PYF08A-N	PYC-A1	PY08(QN)	PYC-P PYC-P2	PY08-02	PYC-P PYC-P2
	4	PYF14A-E PYF14A-N		PY14(QN)		PY14-02	
2-pole test button	2	PYF08A-E PYF08A-N	PYC-E1	PY08(QN)	PYC-P2	PY08-02	PYC-P2

Mounting Plates for Sockets

Socket model	For 1 Socket	For 18 Sockets	For 36 Sockets
PY08, PY08QN(2), PY14, PY14QN(2)	PYP-1	PYP-18	PYP-36

Note: PYP-18 and PYP-36 can be cut into any desired length in accordance with the number of Sockets.

Track and Accessories

Supporting Track (length = 500 mm)	PFP-50N
Supporting Track (length = 1,000 mm)	PFP-100N, PFP-100N2
End Plate	PFP-M
Spacer	PFP-S

Specifications

■ Coil Ratings

Rated voltage		Rated current		Coil Resistance	Coil Induction (reference value)		Must operate voltage	Must release voltage	Max. voltage	Power consumption (approx.)
		50 Hz	60 Hz		Arm. OFF	Arm. ON				
AC	6 V*	214.1 mA	183 mA	12.2 Ω	0.04 H	0.08 H	80% max.	30% min.	110%	1.0 to 1.2 VA (60 Hz)
	12 V	106.5 mA	91 mA	46 Ω	0.17 H	0.33 H				
	24 V	53.8 mA	46 mA	180 Ω	0.69 H	1.30 H				
	48/50 V*	24.7/25.7 mA	21.1/22.0 mA	788 Ω	3.22 H	5.66 H				
	110/120 V	9.9/10.8 mA	8.4/9.2 mA	4,430 Ω	19.20 H	32.1 H				
	220/240 V	4.8/5.3 mA	4.2/4.6 mA	18,790 Ω	83.50 H	136.4 H				0.9 to 1.1 VA (60 Hz)
DC	6 V*	151 mA		39.8 Ω	0.17 H	0.33 H		10% min.		0.9 W
	12 V	75 mA		160 Ω	0.73 H	1.37 H				
	24 V	37.7 mA		636 Ω	3.20 H	5.72 H				
	48 V*	18.8 mA		2,560 Ω	10.60 H	21.0 H				
	100/110 V	9.0/9.9 mA		11,100 Ω	45.60 H	86.2 H				

- Note:** 1. The rated current and coil resistance are measured at a coil temperature of 23°C with tolerances of +15%/–20% for rated currents and ±15% for DC coil resistance.
 2. Performance characteristic data are measured at a coil temperature of 23°C.
 3. AC coil resistance and impedance are provided as reference values (at 60 Hz).
 4. Power consumption drop was measured for the above data. When driving transistors, check leakage current and connect a bleeder resistor if required.
 5. Rated voltage denoted by “*” will be manufactured upon request. Ask your OMRON representative.

■ Contact

Item	2-pole		4-pole		4-pole (bifurcated)	
	Resistive load (cosφ = 1)	Inductive load (cosφ = 0.4, L/R = 7 ms)	Resistive load (cosφ = 1)	Inductive load (cosφ = 0.4, L/R = 7 ms)	Resistive load (cosφ = 1)	Inductive load (cosφ = 0.4, L/R = 7 ms)
Rated Load	5A, 250 VAC 5A, 30 VDC	2A, 250 VAC 2 A, 30 VDC	3 A, 250 VAC 3 A, 30 VDC	0.8 A, 250 VAC 1.5 A, 30 VDC	3 A, 250 VAC 3 A, 30 VDC	0.8 A, 250 VAC 1.5 A, 30 VDC
Carry Current	10 A (see note)		5 A (see note)			
Max. switching voltage	250 VAC 125 VDC		250 VAC 125 VDC			
Max. switching current	10 A		5 A			
Max. switching power	2,500 VA 300 W	1,250 VA 300 W	1,250 VA 150 W	500 VA 150 W	1,250 VA 150 W	500 VA 150 W
Failure rate (reference value)	5 VDC, 1 mA		1 VDC, 1 mA		1 VDC, 100 mA	

■ Characteristics

Item	All relays
Contact resistance	100 mΩ max.
Operate time	20 ms max.
Release time	20 ms max.
Max. operating frequency	Mechanical: 18,000 operations/hr Electrical: 1,800 operations/hr (under rated load)
Insulation resistance	1,000 MΩ min. (at 500 VDC)
Dielectric strength	2,000 VAC, 50/60 Hz for 1.0 min (1,000 VAC between contacts of same polarity)
Vibration resistance	Destruction: 10 to 55 to 10 Hz, 0.5 mm single amplitude (1.0 mm double amplitude) Malfunction: 10 to 55 to 10 Hz, 0.5 mm single amplitude (1.0 mm double amplitude)
Shock resistance	Destruction: 1,000 m/s ² Malfunction: 200 m/s ²
Endurance	See the following table
Ambient temperature	Operating: -55°C to 70°C (with no icing)
Ambient humidity	Operating: 5% to 85%
Weight	Approx. 35 g

Note: The values given above are initial values.

■ Endurance Characteristics

Pole	Mechanical life (at 18,000 operations/hr)	Electrical life (at 18,000 operations/hr under rated load)
2-pole	AC: 50,000,000 operations min.	500,000 operations min.
4-pole	DC: 100,000,000 operations min.	200,000 operations min.
4-pole (bifurcated)	20,000,000 operations min.	100,000 operations min.

■ Approved Standards

VDE Recognitions (File No. 112467UG, IEC 255, VDE 0435)

No. of poles	Coil ratings	Contact ratings	Operations
2	6, 12, 24, 48/50, 100/110 110/120, 200/220, 220/240 VAC	10 A, 250 VAC (cosφ = 1) 10 A, 30 VDC (L/R=0 ms)	10 x 10 ³
4	6, 12, 24, 48, 100/110, 125 VDC	5 A, 250 VAC (cosφ = 1) 5 A, 30 VDC (L/R=0 ms)	100 x 10 ³ MY4Z AC; 50 x 10 ³

UL508 Recognitions (File No. 41515)

No. of poles	Coil ratings	Contact ratings	Operations
2	6 to 240 VAC 6 to 125 VDC	10 A, 30 VDC (General purpose) 10 A, 250 VAC (General purpose)	6 x 10 ³
4		5 A, 250 VAC (General purpose) 5 A, 30 VDC (General purpose)	

CSA C22.2 No. 14 Listings (File No. LR31928)

No. of poles	Coil ratings	Contact ratings	Operations
2	6 to 240 VAC 6 to 125 VDC	10 A, 30 VDC 10 A, 250 VAC	6 x 10 ³
4		5 A, 250 VAC (Same polarity) 5 A, 30 VDC (Same polarity)	

IMQ (File No. EN013 to 016)

No. of poles	Coil ratings	Contact ratings	Operations
2	6, 12, 24, 48/50, 100/110 110/120, 200/220, 220/240 VAC	10 A, 30 VDC 10 A, 250 VAC	10 x 10 ³
4		5 A, 250 VAC 5 A, 30 VDC	100 x 10 ³ MY4Z AC; 50 x 10 ³

LR Recognitions (File No. 98/10014)

No. of poles	Coil ratings	Contact ratings	Operations
2	6 to 240 VAC 6 to 125 VDC	10 A, 250 VAC (Resistive) 2 A, 250 VAC (PF0.4) 10 A, 30 VDC (Resistive) 2 A, 30 VDC (L/R=7 ms)	50 x 10 ³
4		5 A, 250 VAC (Resistive) 0.8 A, 250 VAC (PF0.4) 5 A, 30 VDC (Resistive) 1.5 A, 30 VDC (L/R=7 ms)	50 x 10 ³

SEV Listings (File No. 99.5 50902.01)

No. of poles	Coil ratings	Contact ratings	Operations
2	6 to 240 VAC 6 to 125 VDC	10 A, 250 VAC 10 A, 30 VDC	10 x 10 ³
4		5 A, 250 VAC 5 A, 30 VDC	100 x 10 ³ MY4Z AC; 50 x 10 ³

Engineering Data

■ Maximum Switching Power

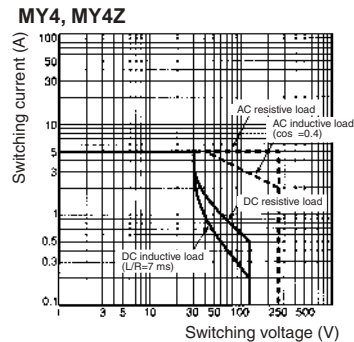
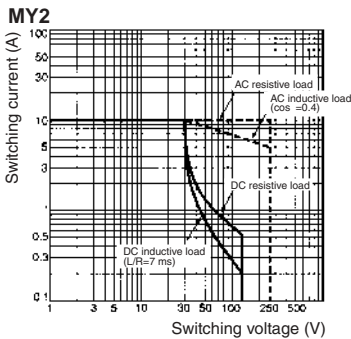

■ Endurance

MY2 (Resistive Loads)

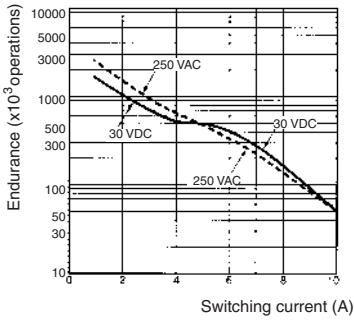

MY2 (Inductive Loads)

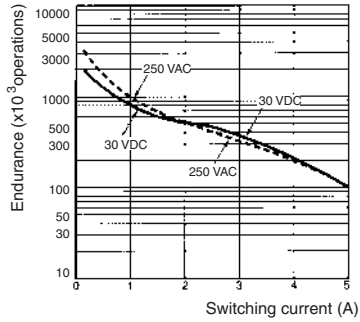

MY4 (Resistive Loads)

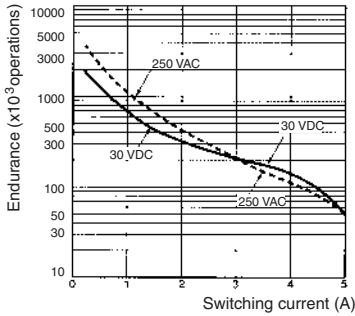

MY4 (Inductive Loads)

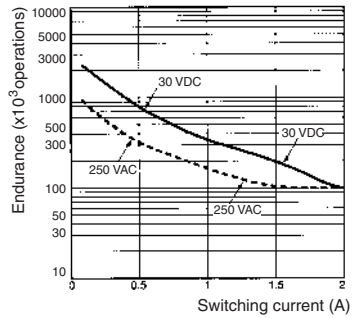

MY4Z (Resistive Loads)

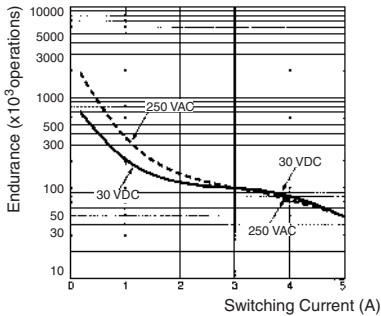

MY4Z (Inductive Loads)

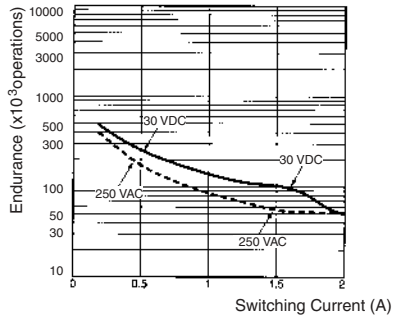

Dimensions

Note: All units are in millimeters unless otherwise indicated.

2-Pole Models

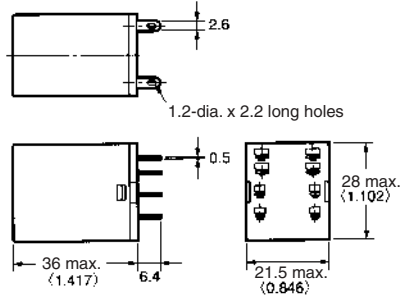
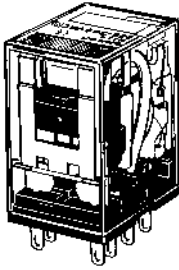

4-Pole Models

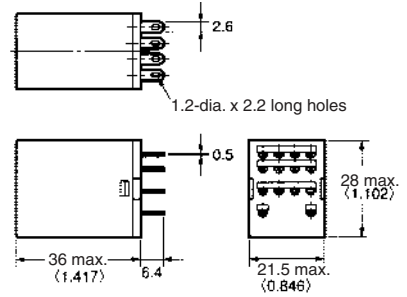
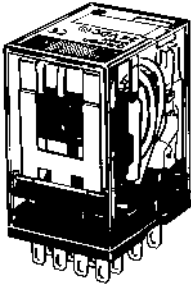

Models with Test Button

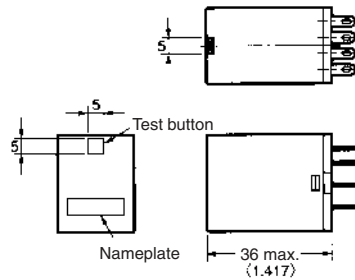
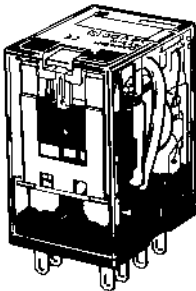

■ Terminal Arrangement/Internal Connections (Bottom View)

MY2

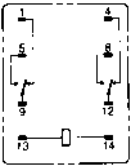

MY2N/MY2IN
(AC Models)

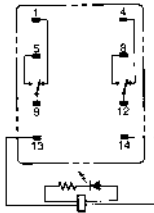

MY2N/MY2IN
(DC Models)

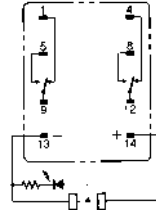

MY2N-D2/MY2IN-D2
(DC Models Only)

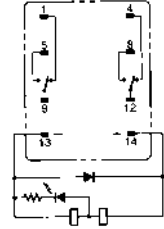

MY2N-CR/MY2IN-CR
(AC Models Only)

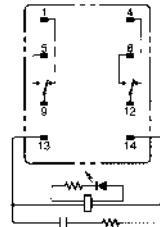

MY2N1/MY2IN1
(DC Models Only)

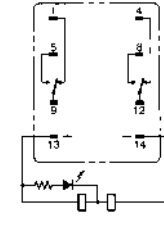

MY2N1-D2/MY2IN1-D2
(DC Models Only)

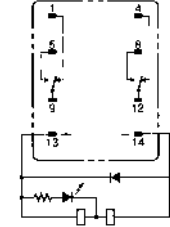

MY4(Z)

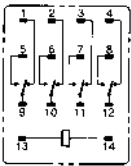

MY4(Z)N/MY4(Z)IN
(AC Models)

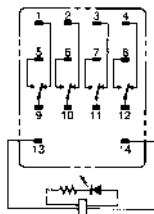

MY4(Z)N/MY4(Z)IN
(DC Models)

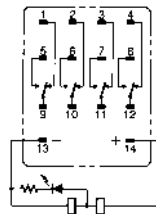

MY4(Z)N-D/MY4(Z)IN-D2
(DC Models Only)

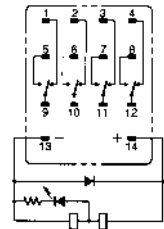

MY4(Z)N-CR/MY4(Z)IN-CR
(AC Models Only)

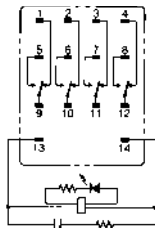

MY4(Z)N1/MY4(Z)IN1
(DC Models Only)

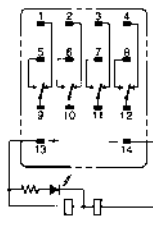

MY4(Z)N1-D2/MY4(Z)IN1-D2
(DC Models Only)

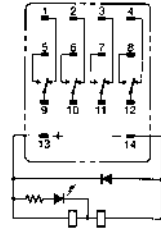

Note: The DC models have polarity.

Socket for MY

**Track-mounted (DIN Track) Socket
Conforms to VDE 0106, Part 100**

- Snap into position along continuous sections of any mounting track.
- Facilitates sheet metal design by standardized mounting dimensions.
- Design with sufficient dielectric separation between terminals eliminates the need of any insulating sheet.



Safety Standards for Sockets

Model	Standards	File No.
PYF08A-E, PYF08A-N PYF14A-E, PYF14A-N	UL508	E87929
	CSA22.2	LR31928

Back-connecting Sockets

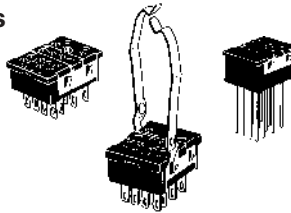

Specifications



Item	Pole	Model	Carry current	Dielectric withstand voltage	Insulation resistance (see note 2)
Track-mounted Socket	2	PYF08A-E	7 A	2,000 VAC, 1 min	1,000 MΩ min.
		PYF08A-N (see note 3)	7 A (see note 4)		
	4	PYF14A-E	5 A		
		PYF14A-N (see note 3)	5 A (see note 4)		
Back-connecting Socket	2	PY08(-Y1)	7 A	1,500 VAC, 1 min	100 MΩ min.
		PY08QN(-Y1)			
		PY08-02			
	4	PY14(-Y1)	3 A		
		PY14QN(-Y1)			
		PY14-02			





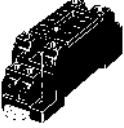
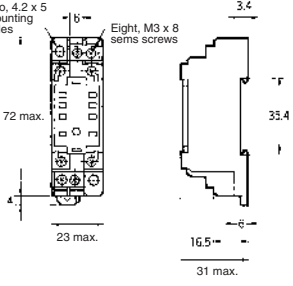
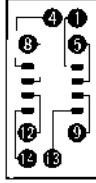
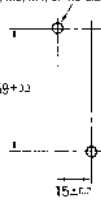
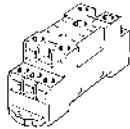
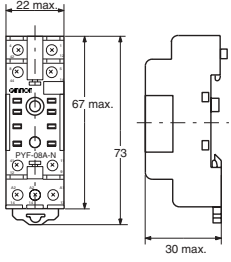
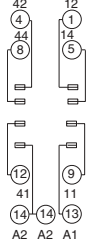
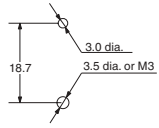
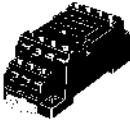
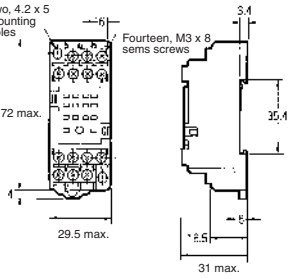
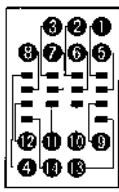
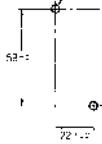

- Note:**
1. The values given above are initial values.
 2. The values for insulation resistance were measured at 500 V at the same place as the dielectric strength.
 3. The maximum operating ambient temperature for the PYF08A-N and PYF14A-N is 55°C.
 4. When using the PYF08A-N or PYF14A-N at an operating ambient temperature exceeding 40°C, reduce the current to 60%.

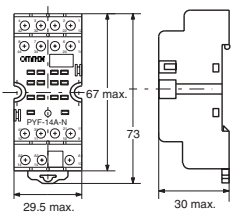
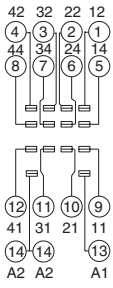
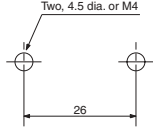
General Purpose Relays

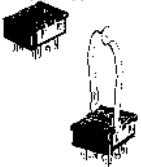
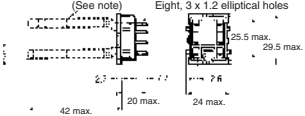
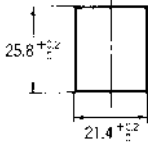
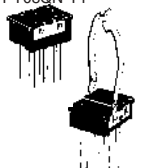
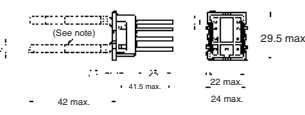
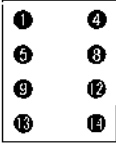
Dimensions

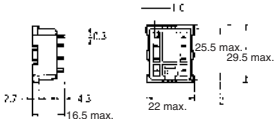
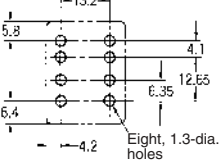
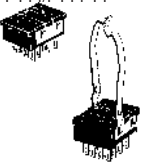
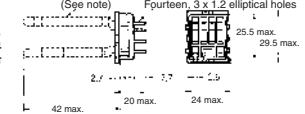
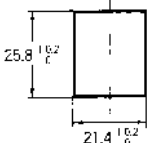
Note: All units are in millimeters unless otherwise indicated.

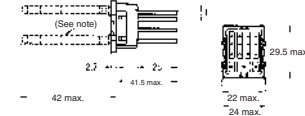
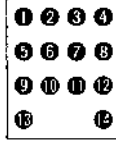
Socket	Dimensions	Terminal arrangement/ Internal connections (top view)	Mounting holes
<p>PYF08A-E</p> 	 <p>Two, 4.2 x 5 mounting holes</p> <p>Eight, M3 x 8 sems screws</p>		 <p>Two, M3, M4, or 4.5-dia. holes</p> <p>58 ± 0.2</p> <p>15 ± 0.2</p> <p>(TOP VIEW)</p> <p>Note: Track mounting is also possible. Refer to page 61 for supporting tracks.</p>
<p>PYF08A-N</p> 			 <p>3.0 dia.</p> <p>18.7</p> <p>3.5 dia. or M3</p> <p>Note: Track mounting is also possible. Refer to page 61 for supporting tracks.</p>
<p>PYF14A-E</p> 	 <p>Two, 4.2 x 5 mounting holes</p> <p>Fourteen, M3 x 8 sems screws</p>		 <p>Two, M3, M4, or 4.5-dia. holes</p> <p>58 ± 0.2</p> <p>72 ± 0.2</p> <p>(TOP VIEW)</p> <p>Note: Track mounting is also possible. Refer to page 61 for supporting tracks.</p>
<p>PYF14A-N</p> 			 <p>Two, 4.5 dia. or M4</p> <p>26</p> <p>Note: Track mounting is also possible. Refer to page 61 for supporting tracks.</p>

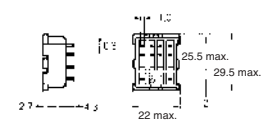
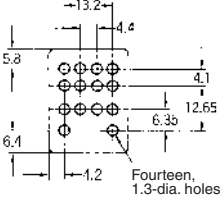
Socket	Dimensions	Terminal arrangement/ Internal connections (bottom view)	Mounting holes
<p>PY08/PY08-Y1</p> 	<p>(See note) Eight, 3 x 1.2 elliptical holes</p>  <p>Note: The PY08-Y1 includes sections indicated by dotted lines.</p>		
<p>PY08QN/ PY08QN-Y1</p> 	<p>(See note)</p>  <p>Note: The PY08QN-Y1 includes sections indicated by dotted lines.</p>		
<p>PY08-02</p> 	<p>1 C</p> 		
<p>PY14/PY14-Y1</p> 	<p>(See note) Fourteen, 3 x 1.2 elliptical holes</p>  <p>Note: The PY14-Y1 includes sections indicated by dotted lines.</p>		
<p>PY14QN/ PY14QN-Y1</p> 	<p>(See note)</p>  <p>Note: The PY14QN-Y1 includes sections indicated by dotted lines.</p>		
<p>PY14-02</p> 	<p>1 C</p> 		

Note: Use a panel with plate thickness of 1 to 2 mm for mounting the Sockets.

■ Hold-down Clips

PYC-A1
(2 pcs per set)

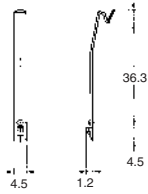

PYC-E1
(2 pcs per set)

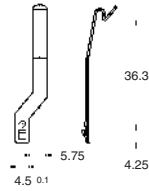

PYC-P

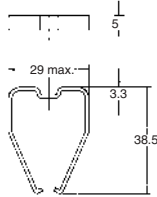

PYC-P2

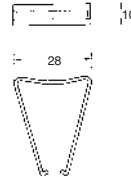

■ Mounting Plates for Back-connecting Sockets

PYP-1

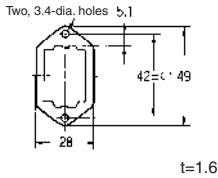

PYP-36

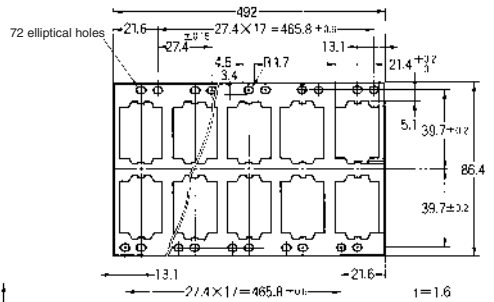

PYP-18

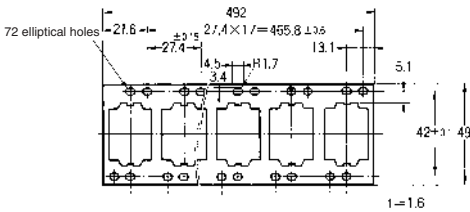

■ Tracks and Accessories

Supporting Tracks

PFP-50N/PFP-100N

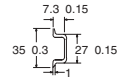
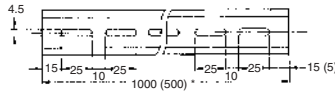

Note: The figure in the parentheses is for PFP-50N.

PFP-100N2

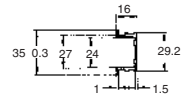
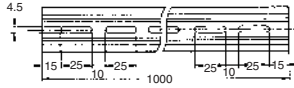

End Plate

PFP-M

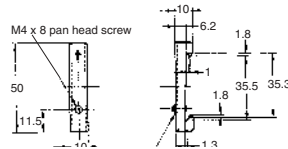
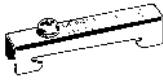

Spacer

PFP-S

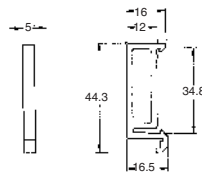
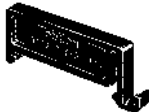

ALL DIMENSIONS SHOWN ARE IN MILLIMETERS.

To convert millimeters into inches, multiply by 0.03937. To convert grams into ounces, multiply by 0.03527.





A Miniature Power Relay

- Equipped with arc barrier.
- Dielectric strength: 2,000 V.
- Built-in diode models added to the LY Series.
- Single-pole and double-pole models are applicable to operating coils with ratings of 100/110 VAC, 110/120 VAC, 200/220 VAC, 220/240 VAC, or 100/110 VDC).
- Three-pole and four-pole models are applicable to operating coils with ratings of 100/110 VAC, 200/220 VAC, or 100/110 VDC).



Ordering Information

■ Open Relays

Type	Contact form	Plug-in/solder terminals 	Plug-in/solder terminals with LED indicator 	PCB terminals 	Upper-mounting plug-in/solder terminals 
Standard	SPDT	LY1	LY1N	LY1-0	LY1F
	DPDT	LY2	LY2N	LY2-0	LY2F
	DPDT (bifurcated)	LY2Z	LY2ZN	LY2Z-0	LY2ZF
	3PDT	LY3	LY3N	LY3-0	LY3F
	4PDT	LY4	LY4N	LY4-0	LY4F
With built-in diode (DC only)	SPDT	LY1-D	LY1N-D2	–	–
	DPDT	LY2-D	LY2N-D2	–	–
	DPDT (bifurcated)	LY2Z-D	LY2ZN-D2	–	–
	3PDT	LY3-D	–	–	–
	4PDT	LY4-D	LY4N-D2	–	–
With built-in CR (AC only)	SPDT	–	–	–	–
	DPDT	LY2-CR	LY2N-CR	–	–
	DPDT (bifurcated)	LY2Z-CR	LY2ZN-CR	–	–

Note: 1. When ordering, add the rated coil voltage to the model number. Rated coil voltages are given in the coil ratings table.

Example: LY2, 6 VAC
6 — Rated coil voltage

2. Relays with #187 quick connect terminals are also available with SPDT and DPDT contact. Ask your OMRON representative for details.
3. SEV models are standard Relays excluding DPDT (bifurcated) models.
4. VDE- or LR- qualifying Relays must be specified when ordering.

■ Accessories (Order Separately)

Sockets

Poles	Front-connecting Socket	Back-connecting Socket		
	DIN track/screw terminals	Plug-in/solder terminals	Wrapping terminals	PCB terminals
1 or 2	PTF08A-E, PTF08A	PT08	PT08QN	PT08-0
3	PTF11A	PT11	PT11QN	PT11-0
4	PTF14A-E, PTF14A	PT14	PT14QN	PT14-0

Note: 1. For PTF08-E and PTF14A-E, see "Track Mounted Socket."
 2. PTF14A (-E) Sockets have met UL and CSA standards: UL 508/CSA C22.2.

Mounting Plates for Sockets

Socket model	For 1 Socket	For 10 Sockets	For 12 Sockets	For 18 Sockets
PT08 PT08QN	PYP-1	-	-	PYP-18
PT11 PT11QN	PTP-1-3	-	PTP-12	-
PT14 PT14QN	PTP-1	PTP-10	-	-

Socket-Hold-down Clip Pairings

Relay type	Poles	Front-connecting Sockets		Back-connecting Sockets	
		Socket model	Clip model	Socket model	Clip model
Standard, bifurcated contacts operation indicator, built-in diode	1, 2	PTF08A-E, PTF08A	PYC-A1	PT08(QN), PT08-0	PYC-P
	3	PTF11A		PT11(QN), PT11-0	
	4	PTF14A-E, PTF14A		PT14(QN), PT14-0	
CR Circuit	2	PTF08A-E, PTF08A	Y92H-3	PT08(QN), PT08-0	PYC-1

Specifications

■ Coil Rating

Single- and Double-pole Relays

	Rated voltage	Rated current		Coil Resistance	Coil Induction (reference value)		Must operate voltage	Must release voltage	Max. voltage	Power consumption (approx.)
		50 Hz	60 Hz		Arm. OFF	Arm. ON				
AC	6 V	214.1 mA	183 mA	12.2 Ω	0.04 H	0.08 H	80% max.	30% min.	110%	1.0 to 1.2 VA (60 Hz)
	12 V	106.5 mA	91 mA	46 Ω	0.17 H	0.33 H				
	24 V	53.8 mA	46 mA	180Ω	0.69 H	1.30 H				
	50 V	25.7 mA	22 mA	788ΩW	3.22 H	5.66 H				
	100/110 V	11.7/12.9mA	10/11 mA	3,750 Ω	14.54 H	24.6 H				
	110/120 V	9.9/10.8 mA	8.4/9.2 mA	4,430 Ω	19.20 H	32.1 H				
	200/220 V	6.2/6.8 mA	5.3/5.8 mA	12,950 Ω	54.75 H	94.07 H				
220/240 V	4.8/5.3 mA	4.2/4.6 mA	18,790 Ω	83.50 H	136.40 H	0.9 to 1 VA (60 Hz)				
DC	6 V	150 mA		40 Ω	0.16 H		0.33 H	10% min.		0.9 W
	12 V	75 mA		160 Ω	0.73 H		1.37 H			
	24 V	36.9 mA		650 Ω	3.20 H	5.72 H				
	48 V	18.5 mA		2,600 Ω	10.6 H	21.0 H				
	100/110 V	9.1/10 mA		11,000 Ω	45.6 H	86.2 H				

Note: See notes on the bottom of next page.

Three-pole Relays

	Rated voltage	Rated current		Coil Resistance	Coil Induction (reference value)		Must operate voltage	Must release voltage	Max. voltage	Power consumption (approx.)
		50 Hz	60 Hz		Arm. OFF	Arm. ON				
AC	6 V	310 mA	270 mA	6.7 Ω	0.03 H	0.05 H	80% max.	30% min.	110%	1.6 to 2.0 VA (60 Hz)
	12 V	159 mA	134 mA	24 Ω	0.12 H	0.21 H				
	24 V	80 mA	67 mA	100 Ω	0.44 H	0.79 H				
	50 V	38 mA	33 mA	410 Ω	2.24 H	3.87 H				
	100/110 V	14.1/16 mA	12.4/13.7 mA	2,300 Ω	10.5 H	18.5 H				
	200/220 V	9.0/10.0 mA	7.7/8.5 mA	8,650 Ω	34.8 H	59.5 H				
DC	6 V	234 mA		25.7 Ω	0.11 H	0.21 H	80% max.	10% min.	110%	1.4 W
	12 V	112 mA		107 Ω	0.45 H	0.98 H				
	24 V	58.6 mA		410 Ω	1.89 H	3.87 H				
	48 V	28.2 mA		1,700 Ω	8.53 H	13.9 H				
	100/110 V	12.7/13 mA		8,500 Ω	29.6 H	54.3 H				

Note: See notes under next table.

Four-pole Relays

	Rated voltage	Rated current		Coil Resistance	Coil Induction (reference value)		Must operate voltage	Must release voltage	Max. voltage	Power consumption (approx.)
		50 Hz	60 Hz		Arm. OFF	Arm. ON				
AC	6 V	386 mA	330 mA	5 Ω	0.02 H	0.04 H	80% max.	30% min.	110%	1.95 to 2.5 VA (60 Hz)
	12 V	199 mA	170 mA	20 Ω	0.10 H	0.17 H				
	24 V	93.6 mA	80 mA	78 Ω	0.38 H	0.67 H				
	50 V	46.8 mA	40 mA	350 Ω	1.74 H	2.88 H				
	100/110 V	22.5/25.5 mA	19/21.8 mA	1,600 Ω	10.5 H	17.3 H				
	200/220 V	11.5/13.1 mA	9.8/11.2 mA	6,700 Ω	33.1 H	57.9 H				
DC	6 V	240 mA		25 Ω	0.09 H	0.21 H	80% max.	10% min.	110%	1.5 W
	12 V	120 mA		100 Ω	0.39 H	0.84 H				
	24 V	69 mA		350 Ω	1.41 H	2.91 H				
	48 V	30 mA		1,600 Ω	6.39 H	13.6 H				
	100/110 V	15/15.9 mA		6,900 Ω	32 H	63.7 H				

Note: 1. The rated current and coil resistance are measured at a coil temperature of 23°C with tolerances of +15%/–20% for rated currents and ±15% for DC coil resistance.

2. Performance characteristic data are measured at a coil temperature of 23°C.

3. AC coil resistance and impedance are provided as reference values (at 60 Hz).

4. Power consumption drop was measured for the above data. When driving transistors, check leakage current and connect a bleeder resistor if required.

■ Contact Rating

Relay	Single Contact				Bifurcated contacts	
	1-pole		2-, 3- or 4-pole		2-pole	
Load	Resistive load (cosφ = 1)	Inductive load (cosφ = 0.4, L/R = 7 ms)	Resistive load (cosφ = 1)	Inductive load (cosφ = 0.4, L/R = 7 ms)	Resistive load (cosφ = 1)	Inductive load (cosφ = 0.4, L/R = 7 ms)
Rated Load	110 VAC 15 A 24 VDC 15 A	110 VAC 10 A 24 VDC 7 A	110 VAC 10 A 24 VDC 10 A	110 VAC 7.5 A 24 VDC 5 A	110 VAC 5A 24 VDC 5 A	110 VAC 4 A 24 VDC 4A
Rated Carry Current	15 A		10 A		7 A	
Max. switching voltage	250 VAC 125 VDC		250 VAC 125 VDC		250 VAC 125 VDC	
Max. switching current	15 A		10 A		7 A	
Max. switching power	1,700 VA 360 W	1,100 VA 170 W	1,100 VA 240 W	825 VA 120 W	550 VA 120 W	440 VA 100 W
Failure rate (reference value)*	100 mA, 5 VDC		100 mA, 5 VDC		100 mA, 5 VDC	

*Note: P level: λ₆₀ = 0.1 x 10⁻⁶/operation

■ Characteristics

Item	All except Relays with bifurcated contacts	Relays with bifurcated contacts
Contact resistance	50 mΩ max.	
Operate time	25 ms max.	
Release time	25 ms max.	
Max. operating frequency	Mechanical: 18,000 operations/hr Electrical: 1,800 operations/hr (under rated load)	
Insulation resistance	100 MΩ min. (at 500 VDC)	
Dielectric strength	1,000 VAC, 50/60 Hz for 1 min between contacts of same polarity 2,000 VAC, 50/60 Hz for 1 min between contacts of different polarity	
Vibration resistance	Destruction: 10 to 55 to 10 Hz, 0.5 mm single amplitude (1.0 mm double amplitude) Malfunction: 10 to 55 to 10 Hz, 0.5 mm single amplitude (1.0 mm double amplitude)	
Shock resistance	Destruction: 1,000 m/s ² Malfunction: 200 m/s ²	
Endurance	Mechanical: AC: 50,000,000 operations min. (at 18,000 operations/hr) DC: 1,00,000,000 operations min. (at 18,000 operations/hr) Electrical: Single-, three-, and four-pole: 200,000 operations min. (at 1,800 operations/hr under rated load) Double-pole: 500,000 operations min. (at 1,800 operations/hr under rated load)	
Ambient temperature*	Operating: Single- and double-pole standard, bifurcated-contact Relays: -25°C to 55°C (with no icing) (-25°C to 70°C if carry current is 4 A or less) All other Relays: -25°C to 40°C (with no icing) (-25°C to 55°C if carry current is 4 A or less)	
Ambient humidity	Operating: 5% to 85%	
Weight	Single- and double-pole: approx. 40 g, three-pole: approx. 50 g, four-pole: approx. 70 g	

Note: 1. The values given above are initial values

2. The upper limit of 40°C for some Relays is because of the relationship between diode junction temperature and the element used.

■ Endurance Under Real Loads (reference only)

LY1

Rated voltage	Load type	Conditions	Operating frequency	Electrical life
100 VAC	AC motor	400 W, 100 VAC single-phase with 35-A inrush current, 7-A current flow	ON for 10 s, OFF for 50 s	50,000 operations
		300 W, 100 VAC with 51-A inrush current, 3-A current flow		100,000 operations
	AC lamp	500 W, 100 VAC with 78-A inrush current, 5-A current flow	ON for 5 s, OFF for 55 s	25,000 operations
		24 VDC with 50-A inrush current, 1-A current flow		100,000 operations
	Capacitor (2,000 μF)	24 VDC with 50-A inrush current, 1-A current flow	ON for 1 s, OFF for 6 s	100,000 operations
	AC solenoid	50 VA with 2.5-A inrush current, 0.25-A current flow	ON for 1 s, OFF for 2 s	1,500,000 operations
100 VA with 5-A inrush current, 0.5-A current flow		800,000 operations		

LY2

Rated voltage	Load type	Conditions	Operating frequency	Electrical life
100 VAC	AC motor	200 W, 100 VAC single-phase with 25-A inrush current, 5-A current flow	ON for 10 s, OFF for 50 s	200,000 operations
		300 W, 100 VAC with 51-A inrush current, 3-A current flow		80,000 operations
	Capacitor (2,000 μF)	24 VDC with 50-A inrush current, 1-A current flow	ON for 1 s, OFF for 15 s	10,000 operations
		24 VDC with 20-A inrush current, 1-A current flow		150,000 operations
	AC solenoid	50 VA with 2.5-A inrush current, 0.25-A current flow	ON for 1 s, OFF for 2 s	1,000,000 operations
		100 VA with 5-A inrush current, 0.5-A current flow		500,000 operations

LY4

Rated voltage	Load type	Conditions	Operating frequency	Electrical life
100 VAC	AC motor	200 W, 200 VAC triple-phase with 5-A inrush current, 1-A current flow	ON for 10 s, OFF for 50 s	500,000 operations
		750 W, 200 VAC triple-phase with 18-A inrush current, 3.5 A current flow		70,000 operations
	AC lamp	300 W, 100 VAC with 51-A inrush current, 3-A current flow	ON for 5 s, OFF for 55 s	50,000 operations
	Capacitor (2,000 μF)	24 VDC with 50-A inrush current, 1-A current flow	ON for 1 s, OFF for 15 s	5,000 operations
		24 VDC with 20-A inrush current, 1-A current flow	ON for 1 s, OFF for 2 s	200,000 operations
	AC solenoid	50 VA with 2.5-A inrush current, 0.25-A current flow	ON for 1 s, OFF for 2 s	1,000,000 operations
100 VA with 5-A inrush current, 0.5-A current flow		500,000 operations		

■ Approved Standards

UL 508 Recognitions (File No. 41643)

No. of poles	Coil ratings	Contact ratings	Operations
1	6 to 240 VAC 6 to 125 VDC	15 A, 30 VDC (Resistive)	6 x 10 ³
		15 A, 240 VAC (General use) TV-5, 120 VAC 1/2 HP, 120 VAC	25 x 10 ³
2		15 A, 28 VDC (Resistive)	6 x 10 ³
		15 A, 120 VAC (Resistive) 12 A, 240 VAC (General use) 1/2 HP, 120 VAC TV-3, 120 VAC	25 x 10 ³
3 and 4		10 A, 30 VDC (Resistive) 10 A, 240 VAC (General use) 1/3 HP, 240 VAC	6 x 10 ³

CSA 22.2 No. 14 Listings (File No. LR31928)

No. of poles	Coil ratings	Contact ratings	Operations
1	6 to 240 VAC 6 to 125 VDC	15 A, 30 VDC (Resistive)	6 x 10 ³
		15 A, 120 VAC (General use) 1/2 HP, 120 VAC TV-5, 120 VAC	25 x 10 ³
2		15 A, 30 VDC (Resistive)	6 x 10 ³
		15 A, 120 VAC (Resistive) 1/2 HP, 120 VAC TV-3, 120 VAC	
3 and 4		10 A, 30 VDC (Resistive) 10 A, 240 VAC (General use)	

SEV Listings (File No. D3,31/137)

No. of poles	Coil ratings	Contact ratings	Operations
1	6 to 240 VAC 6 to 125 VDC	15 A, 24 VDC	6 x 10 ³
2 to 4		15 A, 220 VAC 10 A, 24 VDC 10 A, 220 VAC	

TÜV (File No. R9251226) (IEC255)

No. of poles	Coil ratings	Contact ratings	Operations
1 to 4	6 to 125 VDC 6 to 240 VAC	LY1, LY1-FD 15 A, 110 VAC (cos ϕ = 1) 10 A, 110 VAC (cos ϕ = 0.4) LY2, LY2-FD, LY3, LY3-FD, LY4, LY4-FD 10 A, 110 VAC (cos ϕ = 1) 7.5 A, 110 VAC (cos ϕ = 0.4)	100 x 10 ³

VDE Recognitions (No. 9903UG and 9947UG)

No. of poles	Coil ratings	Contact ratings	Operations
1	6, 12, 24, 50, 110, 220 VAC 6, 12, 24, 48, 110 VDC	10 A, 220 VAC (cos ϕ = 1) 7 A, 220 VAC (cos ϕ = 0.4) 10 A, 28 VDC (L/R=0 ms) 7 A, 28 VDC (L/R=7 ms)	200 x 10 ³
2		7 A, 220 VAC (cos ϕ = 1) 4 A, 220 VAC (cos ϕ = 0.4) 7 A, 28 VDC (L/R=0 ms) 4 A, 28 VDC (L/R=7 ms)	

■ Approved Standards (cont.)
 LR Recognitions (No. 563KOB-204523)

No. of poles	Coil ratings	Contact ratings
2, 4	6 to 240 VAC 6 to 110 VDC	7.5 A, 230 VAC (PF0.4) 5 A, 24 VDC (L/R=7 ms)

Engineering Data

LY1
 Maximum Switching Power

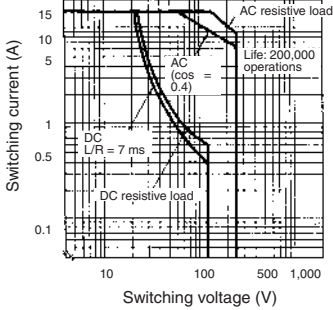

Endurance

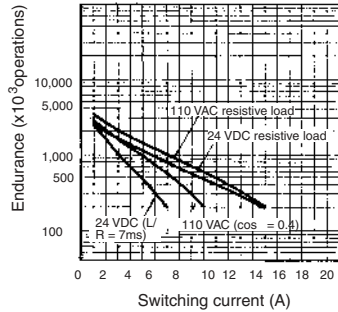

LY2
 Maximum Switching Power

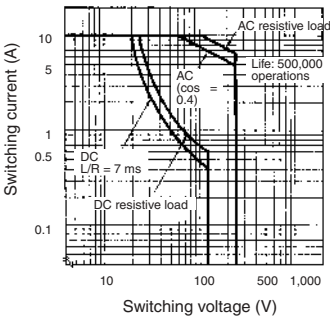

Endurance

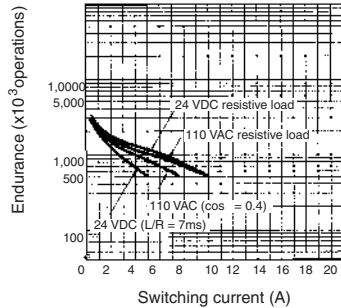

LY3 and LY4
 Maximum Switching Power

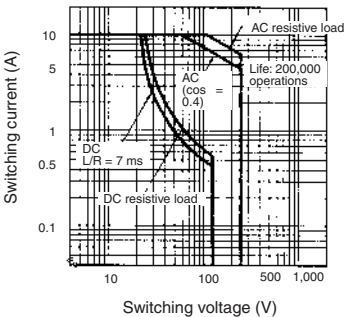

Endurance

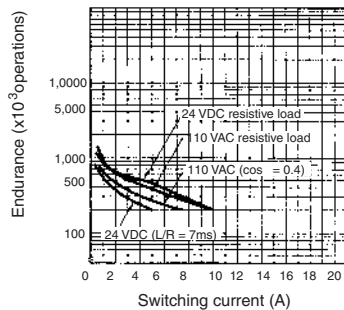

LY2Z
Maximum Switching Power

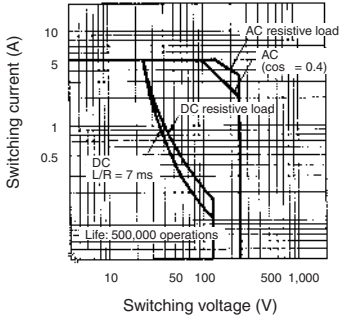

LY2Z
Endurance

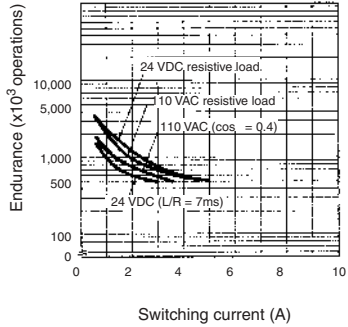

Dimensions

Note: All units are in millimeters unless otherwise indicated.

■ Relays with Solder/Plug-in Terminals

LY1
LY1N (-D2)
LY1-D

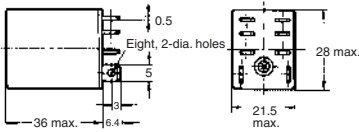

Terminal Arrangement/Internal Connections (Bottom View)

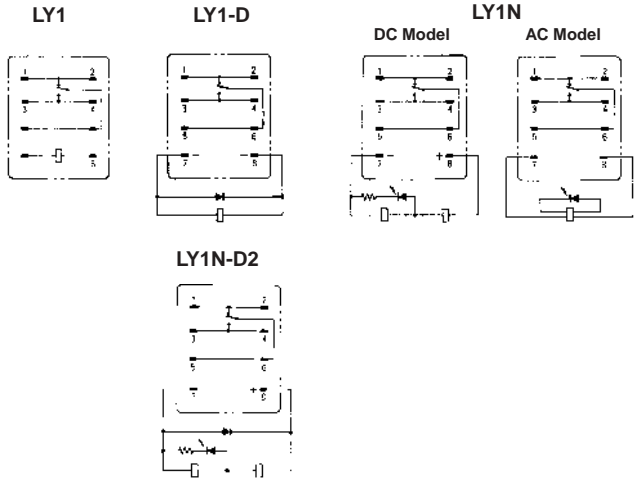

Note: The DC models have polarity.

LY2 LY2Z
 LY2-D LY2Z-D
 LY2N LY2ZN
 LY2N-D2 LY2ZN-D2

Terminal Arrangement/Internal Connections (Bottom View)

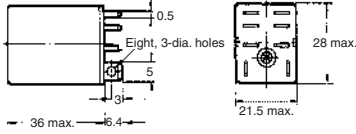
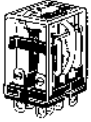

LY2(Z)

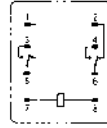

LY2(Z)-D

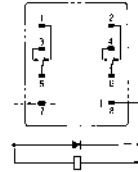

LY2(Z)N

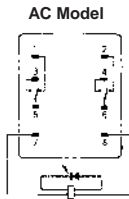
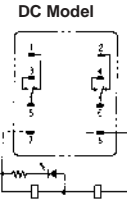

LY2(Z)N-D2

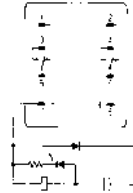

Note: The DC models have polarity.

LY3
 LY3N
 LY3-D

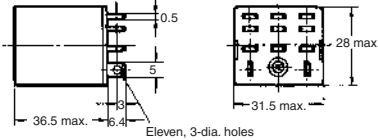
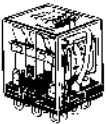

Terminal Arrangement/Internal Connections (Bottom View)

LY3

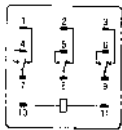

LY3-D

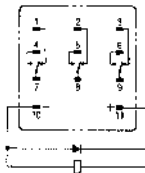

DC Model



LY3N

AC Model

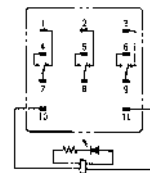

Note: The DC models have polarity.

LY4 LY4N
LY4-D LY4N-D2

Terminal Arrangement/Internal Connections (Bottom View)

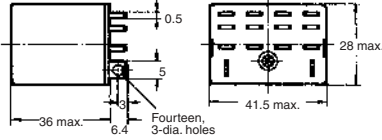
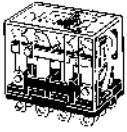

LY4

LY4-D

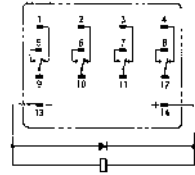
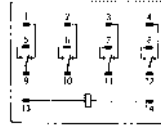

DC Model

LY4N

AC Model

LY4N-D2

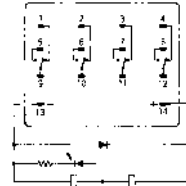
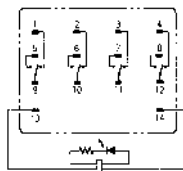
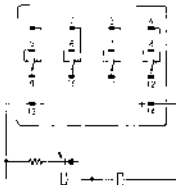

Note: The DC models have polarity.

LY2-CR
LY2Z-CR
LY2N-CR
LY2ZN-CR

Terminal Arrangement/Internal Connections (Bottom View)

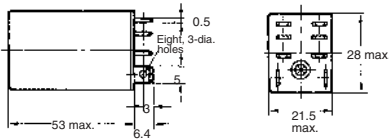

Model: LY2N-CR

LY2(Z)-CR

LY2(Z)N-CR

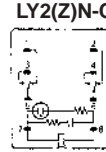
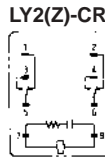

CR Element
C: 0.033 F
R: 120

■ Relays with PCB Terminals

LY1-0 LY3-0
LY2-0 LY4-0

PC Board Holes (Bottom View)

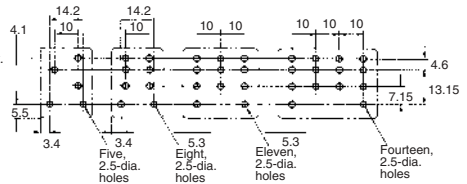
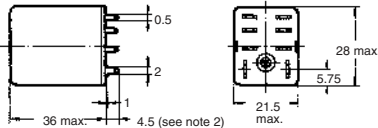
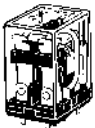

Note: 1. The above model is the LY2-0.
2. This figure is 6.4 for the LY1-0

Note: 1. The tolerance for the above figures is 0.1 mm.
2. Besides the terminals, some part of the LY1-0 carries current. Due attention should be paid when mounting the LY1-0 to a double-sided PC board.

■ Upper Mounting relays

LY1F
LY2F

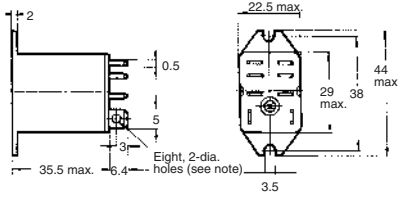
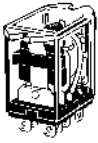

Mounting Holes

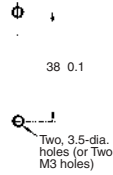

Note: 1. Eight 3-dia. holes should apply to the LY2F model.

LY3F

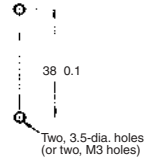
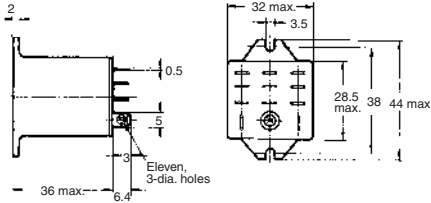
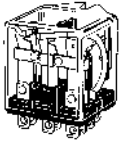

LY4F

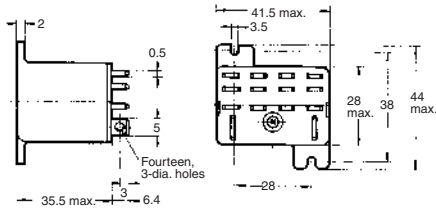
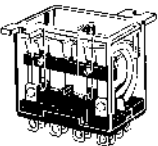

Mounting holes

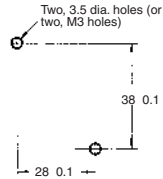

■ Mounting Height with Socket

The following Socket heights should be maintained.

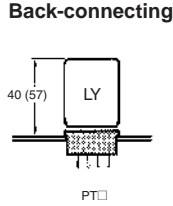
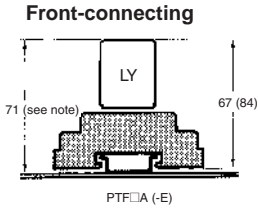

- Note:**
1. The PTF□A (-E) can be track-mounted or screw-mounted.
 2. For the LY□-CR (CR circuit built-in type) model, this figure should be 88.

■ Sockets

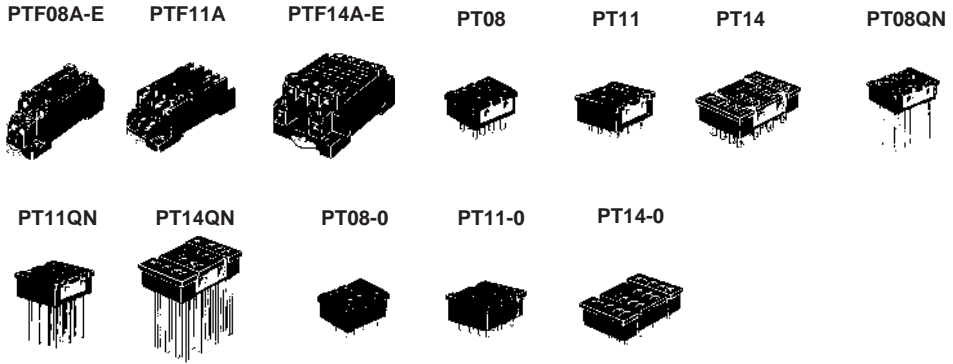



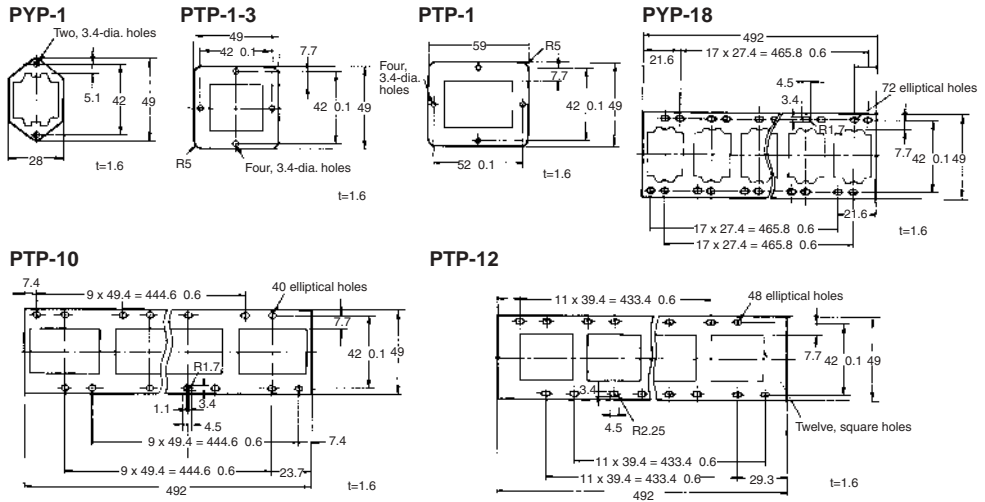

Mounting Plates for Back-connecting



■ Hold-down Clips

Hold-down clips are used to hold Relays to Sockets and prevent them from coming loose due to vibration or shock.

Used with Socket		Used with Socket mounting plate	For CR circuit built-in Relay	
<p>PYC-A1</p> 	<p>PYC-P</p> 	<p>PYC-S</p> 	<p>Y92H-3</p> 	<p>PYC-1</p> 

Precautions

■ Connections

Do not reverse polarity when connecting DC-operated Relays with built-in diodes or indicators.

ALL DIMENSIONS SHOWN ARE IN MILLIMETERS.

To convert millimeters into inches, multiply by 0.03937. To convert grams into ounces, multiply by 0.03527.

■ Accessories (Order Separately)

Connecting Sockets

Applicable Relay model	Track/surface-mounting Socket		Back-mounting Socket	
	Screwless clamp terminal	Screw terminal	Terminals	Model
1 pole G2R-1-S(N)(D)(ND)(NI)(NDI)	• P2RF-05S (See note.) + (P2CM-S (option))	• P2RF-05-E • P2RF-05	PCB terminals Solder terminals	P2R-05P, P2R-057P P2R-05A
2 poles G2R-2-S(N)(D)(ND)(NI)(NDI)	• P2RF-08S (See note.) + (P2CM-S (option))	• P2RF-08-E • P2RF-08	PCB terminals Solder terminals	P2R-08P, P2R-087P P2R-08A

Note: Use of the P2CM Clip & Release Lever is recommended to ensure stable mounting.

Accessories for Screwless Clamp Terminal Socket (Option)

Name	Model
Clip & Release Lever	P2CM-S
Nameplate	R99-11 Nameplate for MY
Socket Bridge	P2RM-SR (for AC), P2RM-SB (for DC)

Mounting Tracks

Applicable Socket	Description	Model
Track-connecting Socket	Mounting track	50 cm (ℓ) x 7.3 mm (t); PFP-50N 1 m (ℓ) x 7.3 mm (t); PFP-100N 1 m (ℓ) x 16 mm (t); PFP-100N2
	End plate	PFP-M
	Spacer	PFP-S
Back-connecting Socket	Mounting plate	P2R-P*

*Used to mount several P2R-05A and P2R-08A Connecting Sockets side by side.

Specifications

■ Coil Ratings

Rated voltage	Rated current*		Coil resistance*	Coil inductance (H) (ref. value)		Must operate voltage	Must release voltage	Max. voltage	Power consumption (approx.)	
	50 Hz	60 Hz		Armature OFF	Armature ON					% of rated voltage
AC	24 V	43.5 mA	37.4 mA	253 Ω	0.81	1.55	80% max.	30% max.	110%	0.9 VA at 60 Hz
	110 V	9.5 mA	8.2 mA	5,566 Ω	13.33	26.83				
	120 V	8.6 mA	7.5 mA	7,286 Ω	16.13	32.46				
	230 V	4.4 mA	3.8 mA	27,172 Ω	72.68	143.90				
	240 V	3.7 mA	3.2 mA	30,360 Ω	90.58	182.34				

Rated voltage	Rated current*		Coil resistance*	Coil inductance (H) (ref. value)		Must operate voltage	Must release voltage	Max. voltage	Power consumption (approx.)
	50 Hz	60 Hz		Armature OFF	Armature ON				
DC	6 V	87.0 mA	69 Ω	0.25	0.48	70% max.	15% min.	110%	0.53 W
	12 V	43.2 mA	278 Ω	0.98	2.35				
	24 V	21.6 mA	1,113 Ω	3.60	8.25				
	48 V	11.4 mA	4,220 Ω	15.2	29.82				

* The rated current and coil resistance are measured at a coil temperature of 23°C with tolerances of ±10%.

■ Contact Ratings

Number of poles	1 pole		2 poles	
Load	Resistive load (cosφ = 1)	Inductive load (cosφ = 0.4; L/R = 7 ms)	Resistive load (cosφ = 1)	Inductive load (cosφ = 0.4; L/R = 7 ms)
Rated load	10 A at 250 VAC; 10 A at 30 VDC	7.5 A at 250 VAC; 5 A at 30 VDC	5 A at 250 VAC; 5 A at 30 VDC	2 A at 250 VAC; 3 A at 30 VDC
Rated carry current	10 A		5 A	
Max. switching voltage	440 VAC, 125 VDC		380 VAC, 125 VDC	
Max. switching current	10 A		5 A	
Max. switching power	2,500 VA, 300 W	1,875 VA, 150 W	1,250 VA, 150 W	500 VA, 90 W
Failure rate (reference value)	100 mA at 5 VDC		10 mA at 5 VDC	

Note: λ_{60}^1 level: $\lambda_{60}^1 = 0.1 \times 10^{-6}$ /operation

■ Characteristics

Item	1 pole	2 poles
Contact resistance	100 mΩ max.	
Operate (set) time	15 ms max.	
Release (reset) time	AC: 10 ms max.; DC: 5 ms max. (w/built-in diode: 20 ms max.)	AC: 15 ms max.; DC: 10 ms max. (w/built-in diode: 20 ms max.)
Max. operating frequency	Mechanical: 18,000 operations/hr Electrical: 1,800 operations/hr (under rated load)	
Insulation resistance	1,000 MΩ min. (at 500 VDC)	
Dielectric strength	5,000 VAC, 50/60 Hz for 1 min between coil and contacts*; 1,000 VAC, 50/60 Hz for 1 min between contacts of same polarity	5,000 VAC, 50/60 Hz for 1 min between coil and contacts*; 3,000 VAC, 50/60 Hz for 1 min between contacts of different polarity 1,000 VAC, 50/60 Hz for 1 min between contacts of same polarity
Vibration resistance	Destruction: 10 to 55 to 10 Hz, 0.75 mm single amplitude (1.5 mm double amplitude) Malfunction: 10 to 55 to 10 Hz, 0.75 mm single amplitude (1.5 mm double amplitude)	
Shock resistance	Destruction: 1,000 m/s ² Malfunction: 200 m/s ² when energized; 100 m/s ² when not energized	
Endurance	Mechanical: AC coil: 10,000,000 operations min.; DC coil: 20,000,000 operations min. (at 18,000 operations/hr) Electrical: 100,000 operations min. (at 1,800 operations/hr under rated load) (DC coil type)	
Ambient temperature	Operating: -40°C to 70°C (with no icing or condensation)	
Ambient humidity	Operating: 5% to 85%	
Weight	Approx. 21 g	

Note: Values given above are initial values

*4,000 VAC, 50/60 Hz for 1 minute when the P2R-05A or P2R-08A Socket is mounted.

■ Approved Standards

UL 508 (File No. E41643)

Model	Contact form	Coil ratings	Contact ratings	Operations
G2R-1-S	SPDT	5 to 110 VDC 5 to 240 VAC	10 A, 30 VDC (resistive) 10 A, 250 VAC (general use) TV-3 (NO contact only)	6 x 10 ³
G2R-2-S	DPDT		5 A, 30 VDC (resistive) 5 A, 250 VAC (general use) TV-3 (NO contact only)	

IEC.VDE (EN61810)

Contact form	Coil ratings	Contact ratings	Operations
1 pole	6, 12, 24, 48 VDC 24, 110, 120, 230, 240 VAC	5 A, 440 VAC (cosφ = 1.0) 10 A, 250 VAC (cosφ = 1.0) 10 A, 30 VDC (0 ms)	100 x 10 ³
2 poles	6, 12, 24, 48 VDC 24, 110, 120, 230, 240 VAC	5 A, 250 VAC (cosφ = 1.0) 5 A, 30 VDC (0 ms)	100 x 10 ³

CSA 22.2 No.0, No.14

(File No. LR31928)

Model	Contact form	Coil ratings	Contact ratings	Operations
G2R-1-S	SPDT	5 to 110 VDC 5 to 240 VAC	10 A, 30 VDC (resistive) 10 A, 250 VAC (general use) TV-3 (NO contact only)	6 x 10 ³
G2R-2-S	DPDT		5 A, 30 VDC (resistive) 5 A, 250 VAC (general use) TV-3 (NO contact only)	

LR

Number of poles	Coil ratings	Contact ratings	Operations
1 pole	5 to 110 VDC 5 to 240 VDC	10 A, 250 VAC (general use) 7.5 A, 250 VAC (PF0.4) 10 A, 30 VDC (resistive) 5A, 30VDC (L/R=7ms)	100 x 10 ³
2 poles	5 to 110 VDC 5 to 240 VDC	5 A, 250 VAC (general use) 2 A, 250 VAC (PF0.4) 5 A, 30 VDC (resistive) 3A, 30VDC (L/R=7ms)	100 x 10 ³

Engineering Data

Maximum Switching Power

Plug-in Relays

G2R-1-S

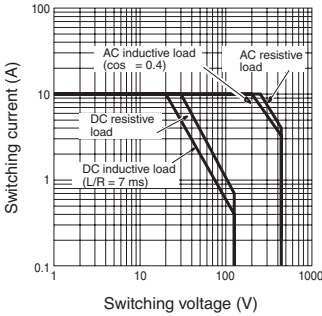

G2R-2-S

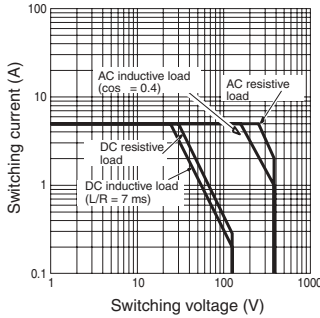

Endurance

Plug-in Relays

G2R-1-S

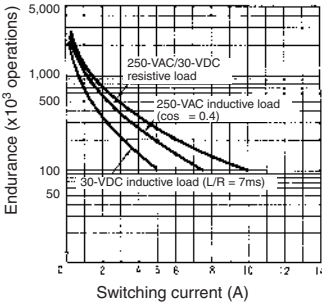

G2R-2-S

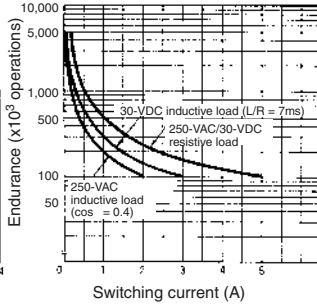

Ambient Temperature vs Maximum Coil Voltage

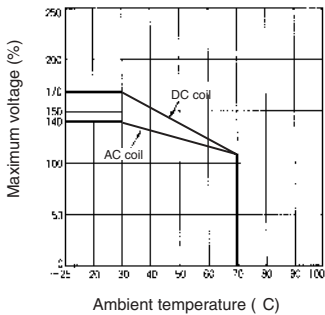

Note: The maximum voltage refers to the maximum value in a varying range of operating power voltage, not a continuous voltage.

Relays with Plug-in Terminals

Note: All units are in millimeters unless otherwise indicated.

SPDT Relays

G2R-1-S, G2R-1-SN, G2R-1-SNI
G2R-1-SD, G2R-1-SND, G2R-1-SNDI

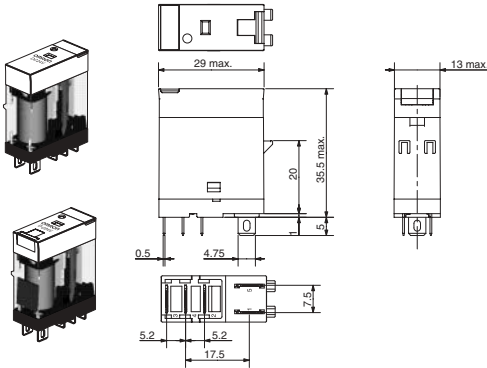

Terminal Arrangement/Internal Connections (Bottom View)

G2R-1-S

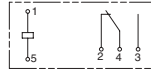

G2R-1-SD (DC)

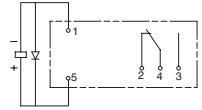

G2R-1-SN, G2R-1-SNI (AC)

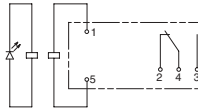

G2R-1-SN, G2R-1-SNI (DC)

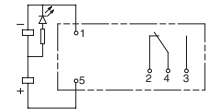

G2R-1-SND, G2R-1-SNDI (DC)

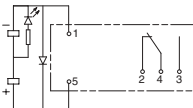

DPDT Relays

G2R-2-S, G2R-2-SN, G2R-2-SNI
G2R-2-SD, G2R-2-SND, G2R-2-SNDI

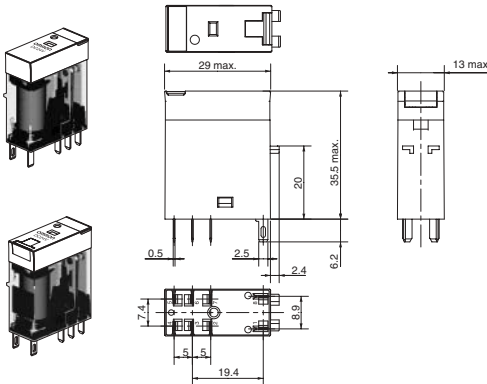

Terminal Arrangement/Internal Connections (Bottom View)

G2R-2-S

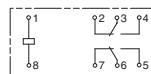

G2R-2-SD (DC)

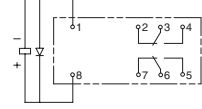

G2R-2-SN, G2R-2-SNI (AC)

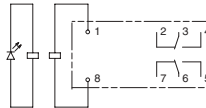

G2R-2-SN, G2R-2-SNI (DC)

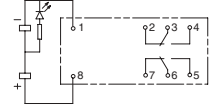

G2R-2-SND, G2R-2-SNDI (DC)

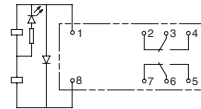

Track/Surface Mounting Sockets

P2RF-05-S

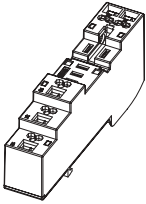

Standard model

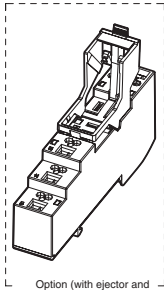

Option (with ejector and label attached)

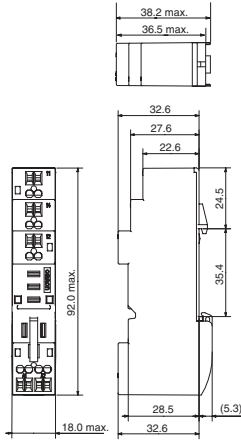

Terminal Arrangement (Top View)

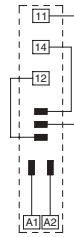

P2RF-08-S

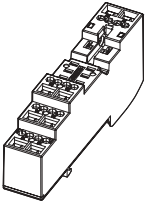

Standard model

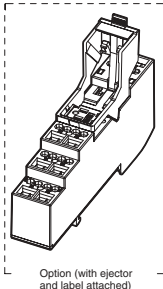

Option (with ejector and label attached)

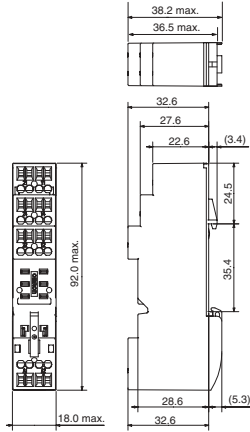

Terminal Arrangement (Top View)

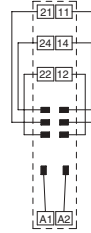

Accessories for P2RF-□-S

Socket Bridge

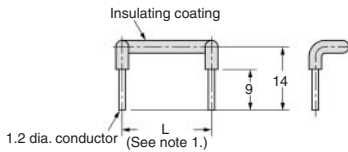

Clip and Reverse Lever

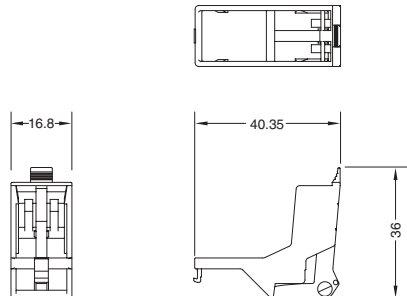

P2RF-05-E

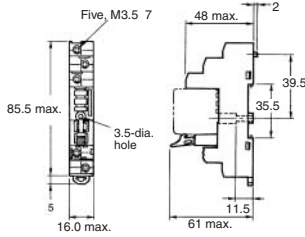
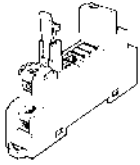

Terminal Arrangement (Top View)

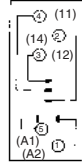

Mounting Holes (for Surface Mounting)

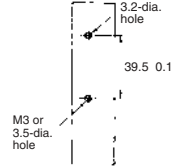

Note: Pin numbers in parentheses apply to DIN standard.

P2RF-08-E

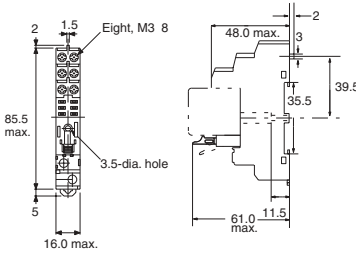
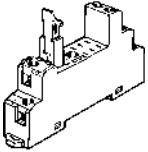

Terminal Arrangement (Top View)

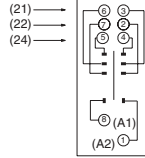

Mounting Holes (for Surface Mounting)

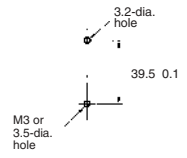

P2RF-05

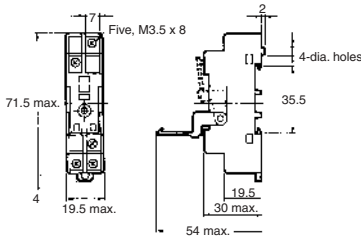

Terminal Arrangement (Top View)



Mounting Holes (for Surface Mounting)

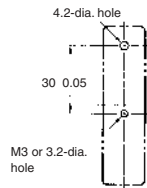

P2RF-08

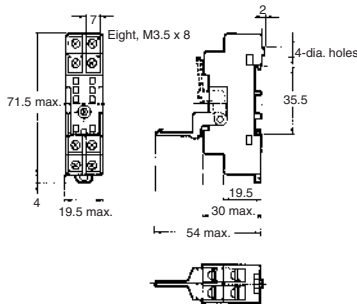
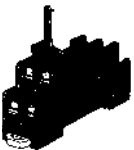

Terminal Arrangement (Top View)

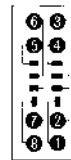

Mounting Holes (for Surface Mounting)

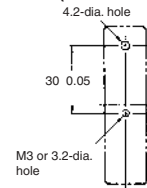

Mounting Height of Relay with Track/Surface Mounting Sockets

P2RF-□

P2RF-□-E

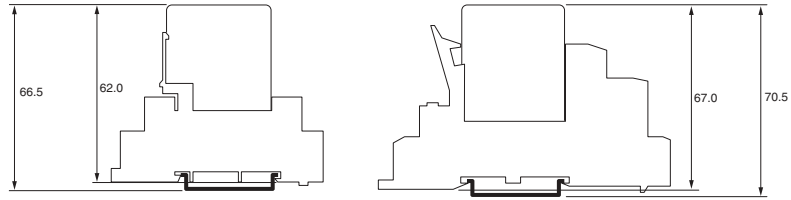

P2RF-□-S

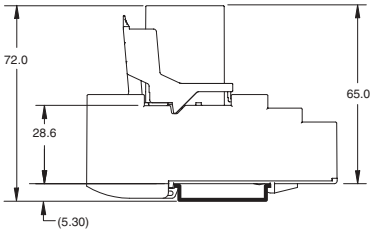

Back-connecting sockets

P2R-05P (1-pole)

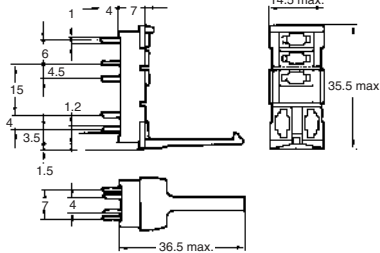

Terminal Arrangement (Bottom View)

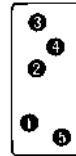

Mounting Holes

Tolerance: 0.1

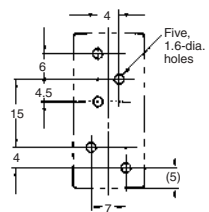

P2R-08P (2-pole)

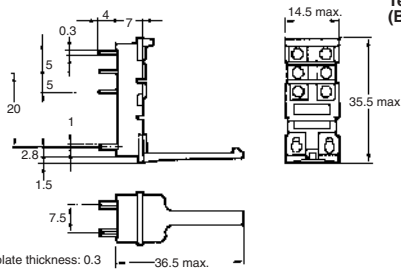

Terminal Arrangement (Bottom View)

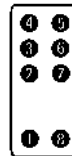

Mounting Holes

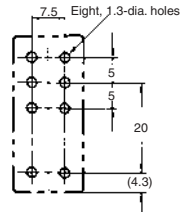

P2R-05A (1-pole)

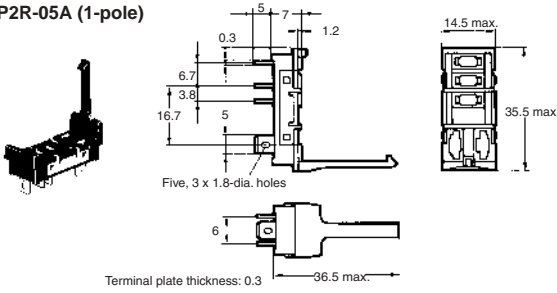

Terminal Arrangement (Bottom View)



Panel Cutout

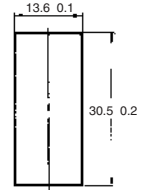

Recommended thickness of the panel is 1.6 to 2.0 mm

P2R-08A (2-pole)

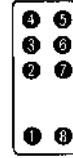
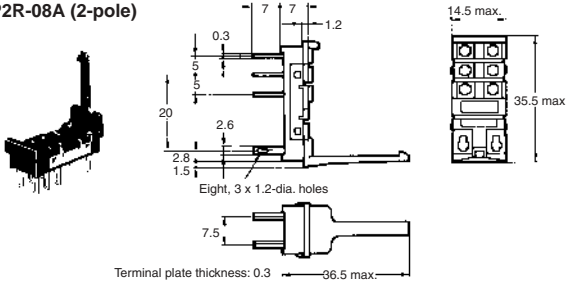

P2R-057P

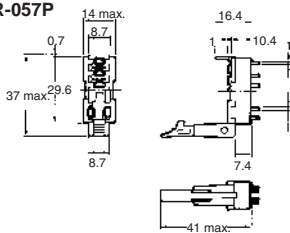

Terminal Arrangement (Bottom View)



Mounting Holes

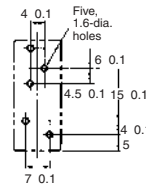

P2R-087P

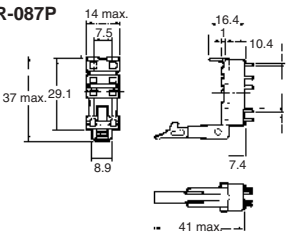

Terminal Arrangement (Bottom View)

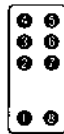

Mounting Holes

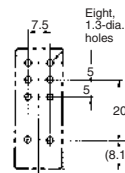

Mounting Height of Relay with Back-connecting Sockets

G2R-□P

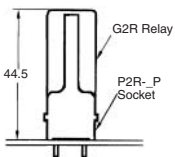

G2R-□A

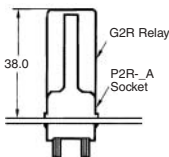

G2R-□7P

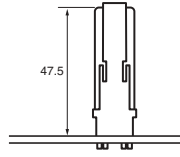

Mounting Tracks

PFP-100N, PFP-50N

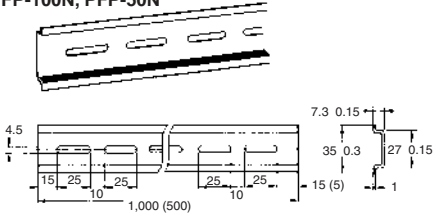

PFP-100N2

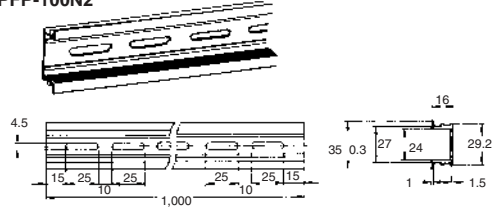

It is recommended to use a panel 1.6 to 2.0 mm thick.

End Plate

PFP-M

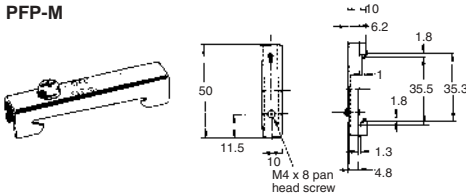

PFP-S

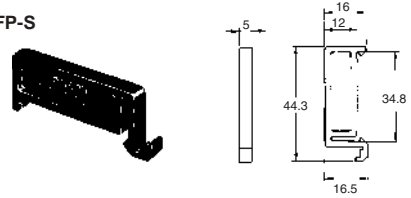

Precautions

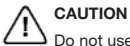

CAUTION

Do not use the test button for any purpose other than testing. Be sure not to touch the test button accidentally as this will turn the contacts ON. Before using the test button, confirm that circuits, the load, and any other connected item will operate safely.

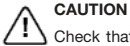

CAUTION

Check that the test button is released before turning ON relay circuits.

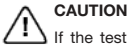

CAUTION

If the test button is pulled out too forcefully, it may bypass the momentary testing position and go straight into the locked position.

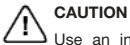

CAUTION

Use an insulated tool when you operate the test button.

PRECAUTIONS FOR P2RF-□-S CONNECTION



- Do not move the screwdriver up, down, or from side to side while it is inserted in the hole. Doing so may cause damage to internal components (e.g., deformation of the clamp spring or cracks in the housing) or cause deterioration of insulation.
- Do not insert the screwdriver at an angle. Doing so may break the side of the socket and result in a short-circuit.

A High-capacity, High-dielectric-strength Relay Compatible with Momentary Voltage Drops

- No contact chattering for momentary voltage drops up to 50% of rated voltage.
- Wide-range AC-activated coil that handles 100 to 120 or 200 to 240 VAC at either 50 or 60 Hz.
- Miniature hinge for maximum switching power, particularly for inductive loads.
- Flame-resistance materials (UL94V-0-qualifying) used for all insulation material.
- Quick-connect, screw, and PCB terminals, and DIN track mounting available.



Ordering Information

Mounting Type	Contact form	Quick-connect terminals 	Screw terminals 	PCB terminals 
E-bracket	SPST-NO	G7L-1A-T	G7L-1A-B	–
	DPST-NO	G7L-2A-T	G7L-2A-B	–
E-bracket (with test button)	SPST-NO	G7L-1A-TJ	G7L-1A-BJ	–
	DPST-NO	G7L-2A-TJ	G7L-2A-BJ	–
Upper bracket	SPST-NO	G7L-1A-TUB	G7L-1A-BUB	–
	DPST-NO	G7L-2A-TUB	G7L-2A-BUB	–
Upper bracket (with test button)	SPST-NO	G7L-1A-TUBJ	G7L-1A-BUBJ	–
	DPST-NO	G7L-2A-TUBJ	G7L-2A-BUBJ	–
PCB mounting	SPST-NO	–	–	G7L-1A-P
	DPST-NO	–	–	G7L-2A-P

Note: 1. When ordering, add the rated coil voltage to the model number.
 Example: G7L-1A-T 12 VAC (V)
 Rated coil voltage

■ Accessories (Order Separately)

Terminals	Contact form	Model	P99-07 E-brackets	P7LF-D DIN Track Mounting Adapter	P7LF-06 Front Connecting Socket
Quick-connect terminals	SPST-NO	G7L-1A-T	Yes	Yes	Yes
		G7L-1A-TJ	Yes	Yes	Yes
	DPST-NO	G7L-2A-T	Yes	Yes	Yes
		G7L-2A-TJ	Yes	Yes	Yes
Screw terminals	SPST-NO	G7L-1A-B	Yes	Yes	No
		G7L-1A-BJ	Yes	Yes	No
	DPST-NO	G7L-2A-B	Yes	Yes	No
		G7L-2A-BJ	Yes	Yes	No

Applicable Relay	Name	Model
G7L-1A-T/G7L-1A-TJ/G7L-1A-B/G7L-1A-BJ G7L-2A-T/G7L-2A-TJ/G7L-2A-B/G7L-2A-BJ	E-bracket	R99-07
	Adapter	P7LF-D
G7L-1A-T/G7L-1A-TJ/G7L-2A-T/G7L-2A-TJ	Front-connecting Socket	P7LF-06
G7L-1A-B/G7L-1A-BJ/G7L-1A-BUB/G7L-1A-BUBJ G7L-2A-B/G7L-2A-BJ/G7L-2A-BUB/G7L-2A-BUBJ	Cover	P7LF-C

Model Number Legend

G7L - -

1 2 3 4 , 5

1. Contact Form

1A: SPST-NO
2A: DPST-NO

2. Terminal Shape

T: Quick-connect terminals
P: PCB terminals
B: Screw terminals

3. Mounting Construction

Blank: E-bracket
UB: Upper bracket

4. Special Functions

Blank: Standard mode
J: With test button

5. Rated Coil Voltage

AC: 12, 24, 50, 100 to 120, 200 to 240
DC: 6, 12, 24, 48, 100

Application Examples

- Compressors for air conditioners and heater switching controllers.
- Switching controllers for power tools or motors.
- Power controllers for water heaters.
- Power controllers for dryers.
- Lamp controls, motor drivers, and power supply switching in copy machines, facsimile machines, and other office equipment.
- Lighting controllers.
- Power controllers for packers or food processing equipment.
- Magnetron control in microwaves.

Specifications

■ Coil Ratings

Rated Voltage		Rated current	Coil resistance	Must operate voltage	Must release voltage	Max. voltage	Power consumption (approx.)
AC (-)	12 V	142 mA	–	75% max. of rated voltage	15% min. of rated voltage	110% of rated voltage	1.7 to 2.5 VA (60 Hz)
	24 V	71 mA	–				
	50 V	34 mA	–				
	100 to 120 V	7.0 to 20.4 mA	–	75 V	18 V	132 V	
	200 to 240 V	8.5 to 10.2 mA	–	150 V	36 V	264 V	
DC (=)	6 V	317 mA	18.9 Ω	75% max. of rated voltage	15% min. of rated voltage	110% of rated voltage	1.9 W
	12 V	158 mA	75 Ω				
	24 V	79 mA	303 Ω				
	48 V	40 mA	1220 Ω				
	100 V	19 mA	5260 Ω				

- Note:** 1. The rated current and coil resistance are measured at a coil temperature of 23°C with tolerances of +15%/–20% for AC rated current and ±15% for DC coil resistance.
 2. Performance characteristic data are measured at a coil temperature of 23°C.
 3. – indicates AC and = indicates DC (IEC417 publications).

■ Contact Ratings

Model	G7L-1A-T@/G7L-1A-B@		G7L-2A-T@/G7L-2A-B@		G7L-1A-P/G7L-2A-P	
	Resistive load (cosφ = 1)	Inductive load (cosφ = 0.4)	Resistive load (cosφ = 1)	Inductive load (cosφ = 0.4)	Resistive load (cosφ = 1)	Inductive load (cosφ = 0.4)
Rated Load	30 A, 220 VAC (-)	25 A, 220 VAC (-)	25 A, 220 VAC (-)		25 A, 220 VAC (-)	
Carry Current	30 A		25 A		20 A	
Max. switching voltage	250 VAC (-)		250 VAC (-)		250 VAC (-)	
Max. switching current	30 A		25 A		20 A	
Max. switching power	6,600 VAC (-)	5,500 VAC (-)	5,500 VAC (-)		4,400 VAC (-)	
Failure rate* (reference value)	100 mA, 5 VDC (-)		100 mA, 5 VDC (-)		100 mA, 5 VDC (-)	

*Note: P level: $\lambda_{60} = 0.1 \times 10^{-6}$ /operation

■ Characteristics

Contact resistance	50 mΩ max.
Operate time	30 ms max.
Release time	30 ms max.
Max. operating frequency	Mechanical: 1,800 operations/hr Electrical: 1,800 operations/hr (under rated load)
Insulation resistance	1,000 MΩ min. (at 500 VDC)
Dielectric strength	4,000 VAC min., 50/60 Hz for 1 min between coil and contacts 2,000 VAC, 50/60 Hz for 1 min between contacts of same polarity 2,000 VAC, 50/60 Hz for 1 min between contacts of different polarity (DPST-NO model)
Impulse withstand voltage	10,000 V between coil and contact (with 1.2 x 50 μs impulse wave)
Vibration resistance	Destruction: 10 to 55 to, 0.75 mm single amplitude (1.5 mm double amplitude) Malfunction: 10 to 55 to, 0.75 mm single amplitude (1.5 mm double amplitude)
Shock resistance	Destruction: 1,000 m/s ² Malfunction: 100 m/s ²
Endurance	Mechanical: 1,000,000 operations min. (at 1,800 operations/hr) Electrical: 100,000 operations min. (at 1,800 operations/hr under rated load)
Ambient temperature	Operating: -25°C to 60°C (with no icing)
Ambient humidity	Operating: 5% to 85%
Weight	Quick-connect terminal models: approx. 90 g PCB terminal models: approx. 100 g Screw terminal models: approx. 120 g

Note: The values given above are initial values

■ Approved by Standards

UL 508, 1950 Recognitions (File No. E41643)

CSA 22.2 No.14 Listings (File No.LR35535)

Model	Contact Form	Coil ratings	Contact ratings	Operations
G7L-1A-T@ G7L-1A-B@	SPST-NO	12 to 240 VAC 5 to 220 VDC	30 A, 277 VAC (RES) 25 A, 277 VAC (GEN) 30 A, 120 VAC (GEN)	100 x 10 ³
			1.5 kW, 120 VAC (T) 1.5 HP, 120 VAC	6 x 10 ³
			3 HP, 277 VAC	100 x 10 ³ (CSA; 6 x 10 ³)
			20 FLA/120 LRA, 120 VAC 17 FLA/102 LRA, 265 VAC	30 x 10 ³
G7L-2A-T@ G7L-2A-B@	DPST-NO		TV-10, 120 VAC	25 x 10 ³
			25 A, 277 VAC (RES) 25 A, 277 VAC (GEN) 25 A, 120 VAC (GEN)	100 x 10 ³
			1.3 kW, 120 VAC (T) 1 HP, 120 VAC	6 x 10 ³
			2 HP, 277 VAC	100 x 10 ³ (CSA; 6 x 10 ³)
20 FLA/120 LRA, 120 VAC 17 FLA/102 LRA, 265 VAC	30 x 10 ³			
G7L-1A-P	SPST-NO		TV-8, 120 VAC	25 x 10 ³
			20 A, 277 VAC (RES) 20 A, 277 VAC (GEN) 20 A, 120 VAC (GEN)	100 x 10 ³
			1.5 kW, 120 VAC (T) 1.5 HP, 120 VAC	6 x 10 ³
			3 HP, 277 VAC	100 x 10 ³ (CSA; 6 x 10 ³)
20 FLA/120 LRA, 120 VAC 17 FLA/102 LRA, 265 VAC	30 x 10 ³			
G7L-2A-P	DPST-NO		TV-10, 120 VAC	25 x 10 ³
			20 A, 277 VAC (RES) 20 A, 277 VAC (GEN) 20 A, 120 VAC (GEN)	100 x 10 ³
			1.3 kW, 120 VAC (T) 1 HP, 120 VAC	6 x 10 ³
			2 HP, 277 VAC 20 FLA/120 LRA, 120 VAC 17 FLA/102 LRA, 265 VAC	100 x 10 ³ 30 x 10 ³
TV-8, 120 VAC	25 x 10 ³			

TÜV: File No. R9051158 (VDE 0435, IEC 255, IEC 950, EN60950)

Model	Contact Form	Coil ratings	Contact ratings	Operations
G7L-1A-B@	SPST-NO	6, 12, 24, 48, 100, 110, 200, 220 VDC 12, 24, 50, 100 to 120, 200 to 240 VAC	30 A, 240 VAC ($\cos\phi = 1.0$) 25 A, 240 VAC ($\cos\phi = 0.4$) 30 A, 120 VAC ($\cos\phi = 0.4$)	100 x 10 ³
G7L-2A-B@	DPST-NO		25 A, 240 VAC ($\cos\phi = 1.0$) 25 A, 240 VAC ($\cos\phi = 0.4$)	
G7L-1A-T@	SPST-NO		25 A, 240 VAC ($\cos\phi = 1.0$) 25 A, 240 VAC ($\cos\phi = 0.4$)	
G7L-2A-T@	DPST-NO		25 A, 240 VAC ($\cos\phi = 1.0$) 25 A, 240 VAC ($\cos\phi = 0.4$)	
G7L-1A-P	SPST-NO		20 A, 240 VAC ($\cos\phi = 1.0$) 20 A, 240 VAC ($\cos\phi = 0.4$)	
G7L-2A-P	DPST-NO		20 A, 240 VAC ($\cos\phi = 1.0$) 20 A, 240 VAC ($\cos\phi = 0.4$)	

Engineering Data

G7L-1A-T/G7L-1A-B

Maximum Switching Power

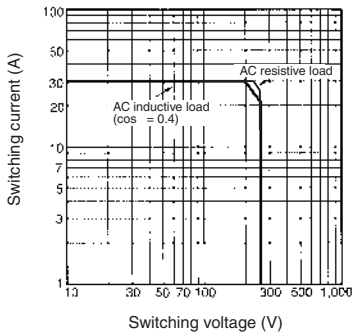

Endurance

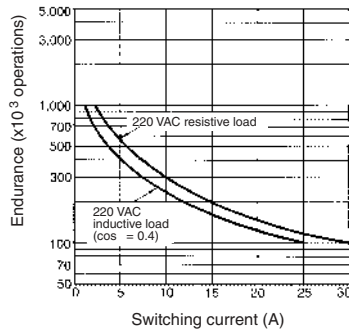

G7L-2A-T/G7L-2A-B

Maximum Switching Power

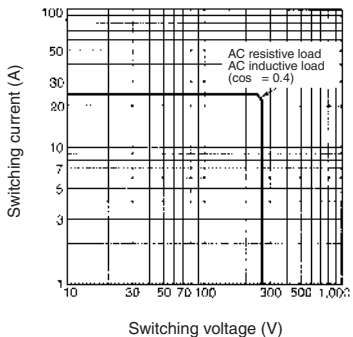

Endurance

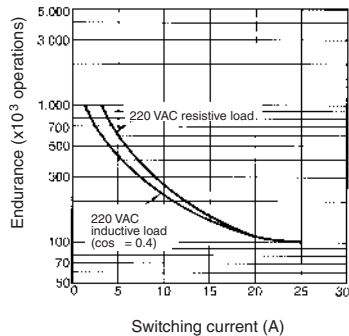

Engineering Data

G7L-1A-P/G7L-2A-P
Maximum Switching Power

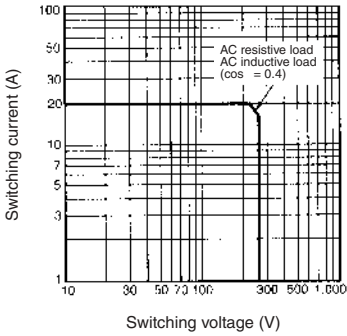

Endurance

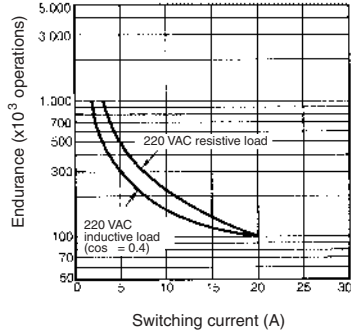

Dimensions

Note: 1. All units are in millimeters unless otherwise indicated.
2. E-brackets are sold separately.

■ Quick-connect Terminals with E-bracket

G7L-1A-T

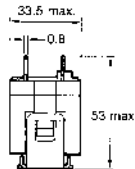
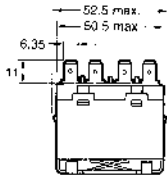
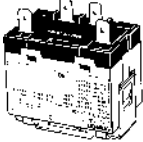

Terminal Arrangement/
Internal Connections
(Top View)



Mounting Holes

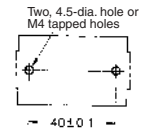

G7L-2A-T

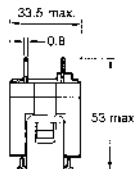
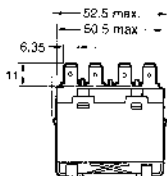
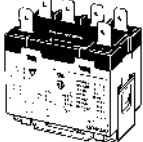

G7L-1A-TJ
with Test Button

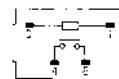
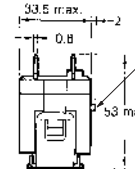
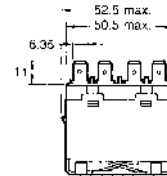
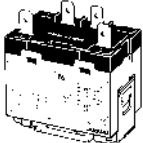

■ Quick-connect Terminals with E-bracket (contd)

G7L-2A-TJ
with Test Button

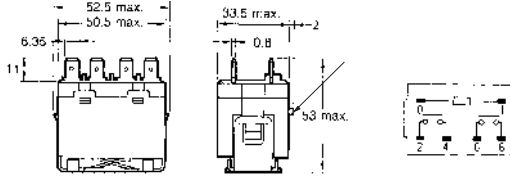
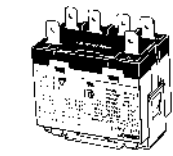

■ Quick-connect Terminals with DIN Track Mounting Adapter

- Note: 1. The DIN Track Mounting Adapter and DIN tracks are sold separately.
2. The DIN Track Mounting Adapter can be track-mounted or screw-mounted.

G7L-1A-T

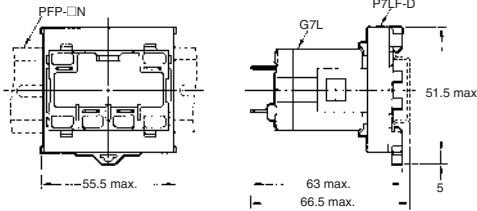
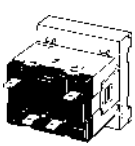

Terminal Arrangement/
Internal Connections
(Top View)

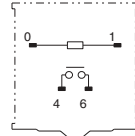

Mounting Holes

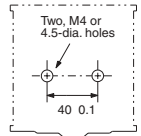

G7L-2A-T

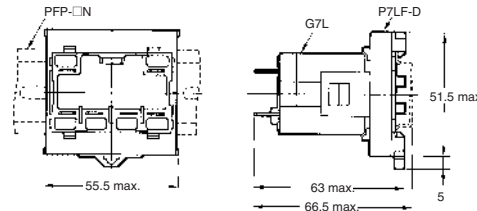
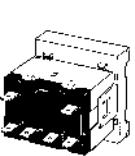

Terminal Arrangement/
Internal Connections
(Top View)

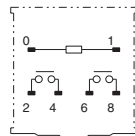

Mounting Holes

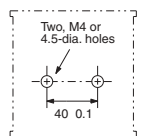

G7L-1A-TJ
with Test Button

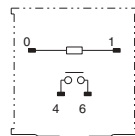
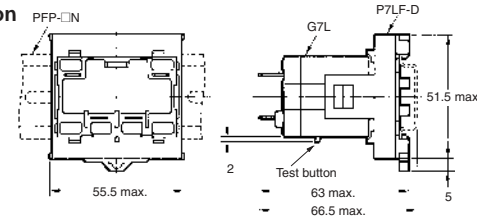
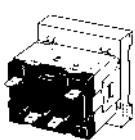

G7L-2A-TJ
with Test Button

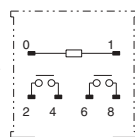
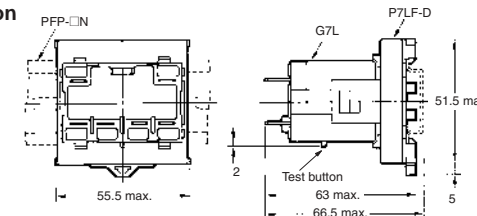
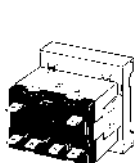

■ Quick-connect Terminals with Front-connecting Socket

Note: 1. The Front-connecting Socket and DIN tracks are sold separately.
 2. The Front-connecting Socket can be track-mounted or screw-mounted.

G7L-1A-T

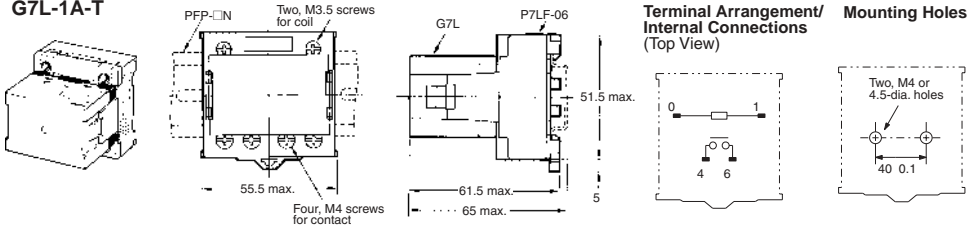

G7L-2A-T

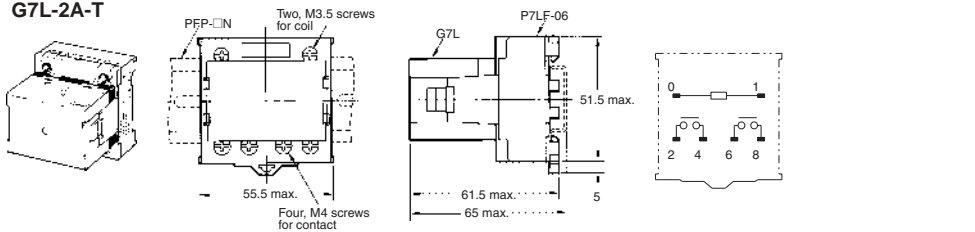

G7L-1A-TJ with Test Button

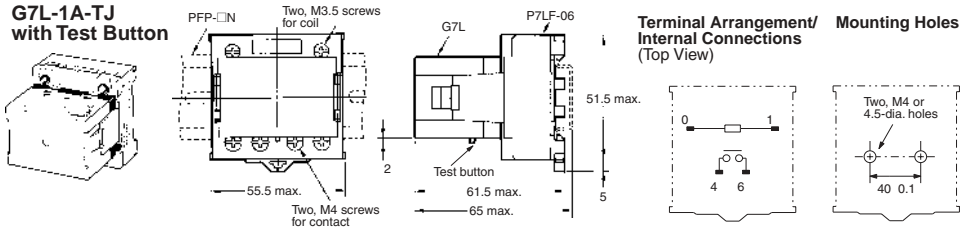

G7L-2A-TJ with Test Button

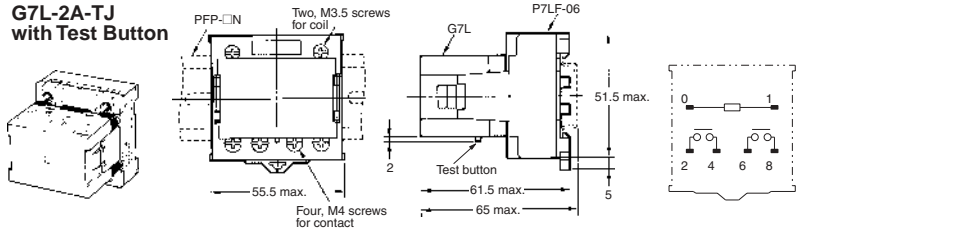

■ Quick-connect Terminals with Upper Bracket

G7L-1A-TUB

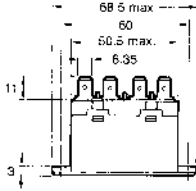
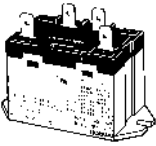

Terminal Arrangement/
Internal Connections
(Top View)

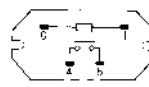

Mounting Holes

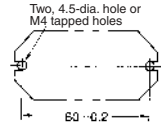

G7L-2A-TUB

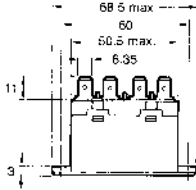
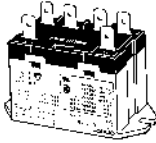

Terminal Arrangement/
Internal Connections
(Top View)

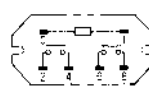

G7L-1A-TUBJ
with Test Button

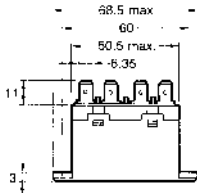
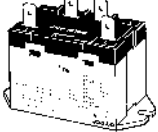

Terminal Arrangement/
Internal Connections
(Top View)

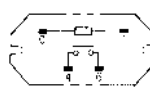

G7L-2A-TUBJ
with Test Button

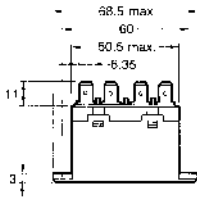
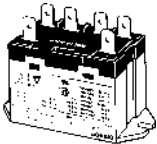

Terminal Arrangement/
Internal Connections
(Top View)

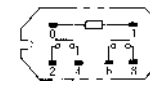

Mounting Holes

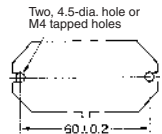

■ Screw Terminals with E-bracket

Note: E-brackets are sold separately.

G7L-1A-B

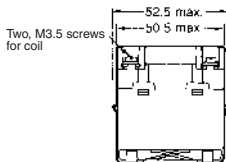
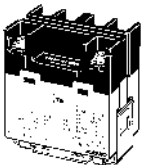

Terminal Arrangement/
Internal Connections
(Top View)

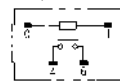

Mounting Holes

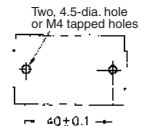

■ Screw Terminals with E-bracket (contd)

E-brackets are sold separately.

G7L-2A-B

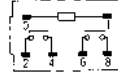
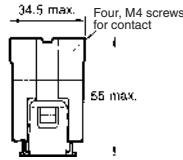
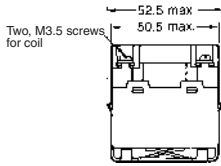
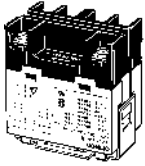

G7L-1A-BJ with Test Button

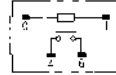
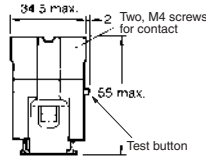
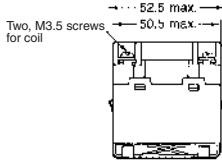
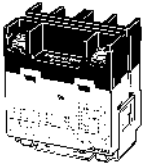

G7L-2A-BJ with Test Button

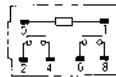
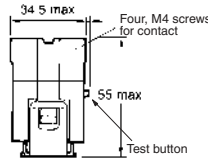
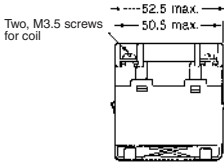
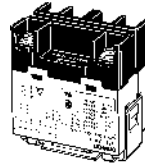

■ Screw Terminals with DIN Track Mounting Adapter

- Note: 1. The DIN Track Mounting Adapter and DIN tracks are sold separately.
- 2. The DIN Track Mounting Adapter can be track-mounted or screw-mounted.

G7L-1A-B

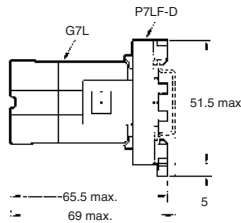
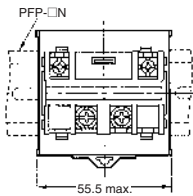
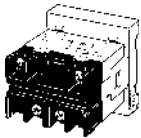

Terminal Arrangement/
Internal Connections
(Top View) Mounting Holes

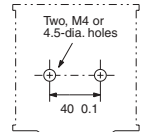
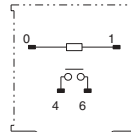

G7L-2A-B

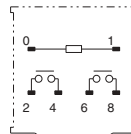
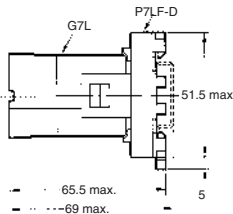
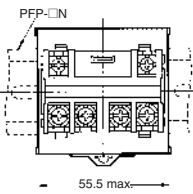
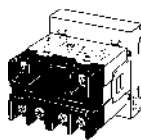

■ Screw Terminals with DIN Track Mounting Adapter (contd)

Note: 1. The DIN Track Mounting Adapter and DIN tracks are sold separately.
 2. The DIN Track Mounting Adapter can be track-mounted or screw-mounted.

G7L-1A-BJ
with Test Button

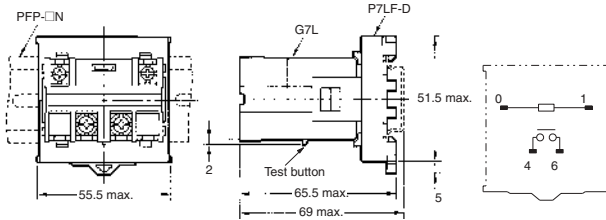
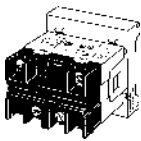

G7L-2A-BJ
with Test Button

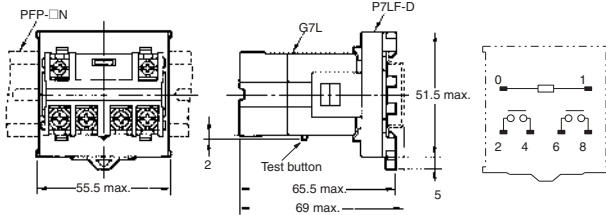
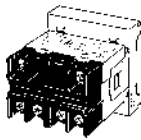

■ Screw Terminals with Upper Bracket

G7L-1A-BUB

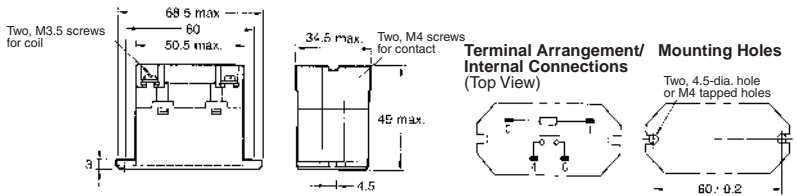
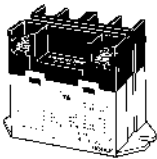

G7L-2A-BUB

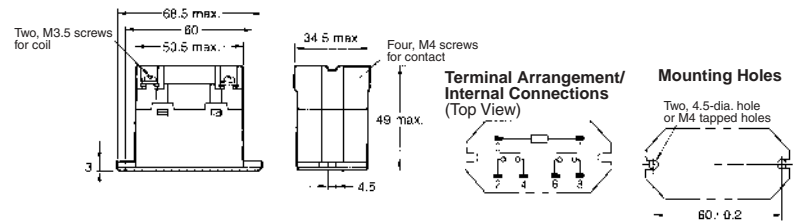
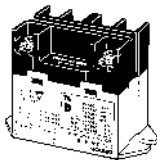

G7L-1A-BUBJ
with Test Button

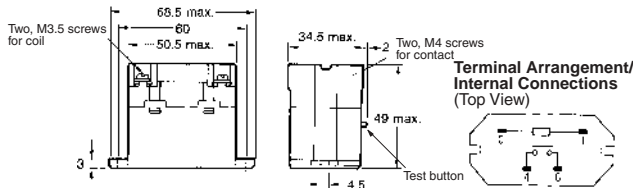
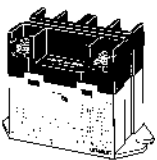

■ Screw Terminals with Upper Bracket (contd)

G7L-2A-BUBJ
with Test Button

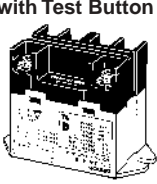

Two, M3.5 screws
for coil

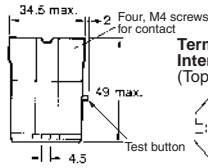
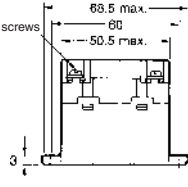

Terminal Arrangement/
Internal Connections
(Top View)

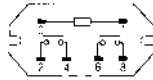

■ PCB Terminals with PCB Mounting

G7L-1A-P

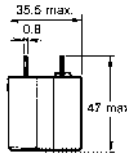
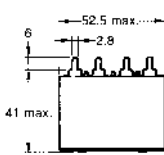
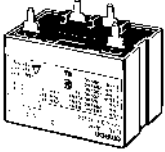

Terminal Arrangement/
Internal Connections
(Top View)

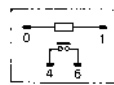

Mounting Holes
(Bottom View)

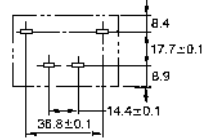

G7L-2A-P

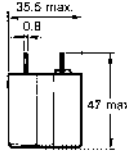
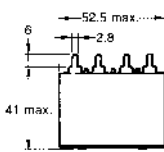
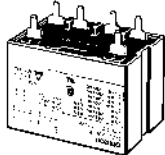

Terminal Arrangement/
Internal Connections
(Top View)

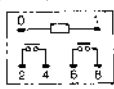

Mounting Holes
(Bottom View)

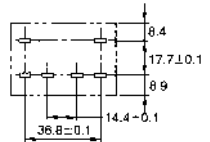

R99-07G5D
E-bracket

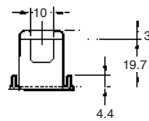
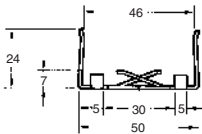
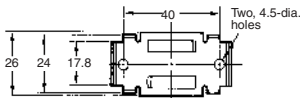

Mounting Holes
(Bottom View)

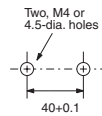

P7LF-D Adapter

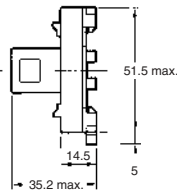
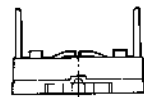
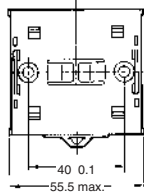
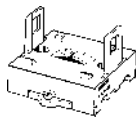

Mounting Holes
(Bottom View)

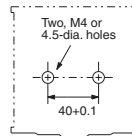

■ PCB Terminals with PCB Mounting (contd)

P7LF-06
Front-connecting
Socket

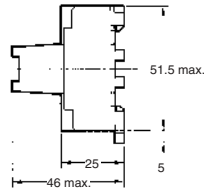
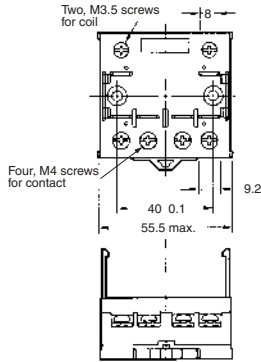
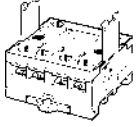

Mounting Holes
(Bottom View)

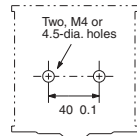

P7LF-C Cover

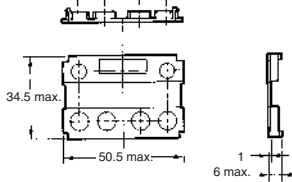

Put the P7LF-C cover onto the terminals in order to protect the user from electric shock.

■ Internal Coil Circuit

DC Operating Coil

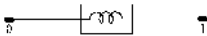

AC Operating Coil

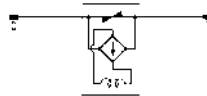

Precautions

HANDLING

- To preserve performance, do not drop or otherwise subject the Power Relay to shock.
- The case is not designed to be removed during normal handling and operation. Doing so may affect performance.
- Use the Power Relay in a dry environment free from excessive dust, SO₂, H₂S, or organic gas.
- Do not allow a voltage greater than the maximum allowable coil voltage to be applied continuously.
- Do not use the Power Relay outside of specified voltages and currents.
- Do not allow the ambient operating temperature to exceed the specified limit.

INSTALLATION

- Although there are not specific limits on the installation site, it should be as dry and dust-free as possible.
- PCB Terminal-equipped Relays weigh approximately 100 g. Be sure that the PCB is strong enough to support them. We recommend dual-side through-hole PCBs to reduce solder cracking from heat stress.
- Quick-connect terminals can be connected to Faston receptacle #250 and positive-lock connectors.
- Allow suitable slack on leads when wiring, and do not subject the terminals to excessive force.
- G7L Relays with test buttons must be mounted facing down.
- Be careful not to touch the test button accidentally. Doing so may turn ON the contact.
- Use the test button only to check the electrical conductivity. Do not switch the load directly by pushing the test button.

CLEANING PCB TERMINALS

- PCB terminals have flux-tight construction which prevents flux from penetrating into the Relay base housing, e.g., due to capillary action up the terminals when Relay is soldered onto the PCB. This type of Relay cannot be immersed for cleaning.

CONNECTING

- Refer to the following table when connecting a wire with a crimp-style terminal to the G7L.

Terminals	Screw terminals	Front-connecting Socket
Coil		
Contact		

RATED CURRENT FLOW

- When using B-series (screw) products, the rated current from the screw terminals (M4) should be 20 A or less according to jet standard (electrical appliance and material control law of Japan).

OPERATING COIL

- As a rule, either a DC battery or a DC power supply with a maximum of 5% ripple must be used for the operating voltage for DC Relays. Before using a rectified AC supply, confirm that the ripple is not greater than 5%. Ripple greater than this can lead to variations in the operating and reset voltages.

As excessive ripple can generate pulses, the insertion of a smoothing capacitor is recommended as shown below.

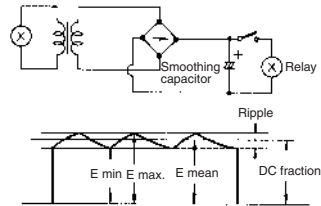

$$\% \text{ of ripple} = \frac{E \text{ max.} - E \text{ min.}}{E \text{ mean}} \times 100$$

E max.: Max. ripple
E min.: Min. ripple
E mean: Mean DC value

- When driving a transistor, check the leakage current and connect a bleeder resistor if necessary.

DIN TRACK MOUNTING ADAPTER AND FRONT-CONNECTING SOCKET

DIN Track Mounting

- Use a DIN-conforming 50-cm track or 1-m track (both are sold separately) for mounting a number of G7L Relays.
- Cut and shorten the track to an appropriate length if the required track length is less than 50 cm.
- The DIN Track Mounting Adapter and Front-connecting Socket can be mounted on the G7L with just one hand and dismounted with ease by using a screwdriver.
- To support the G7L mounted on a DIN Track Mounting Adapter or Front-connecting Socket, use the PFP-M End Plate. Put the End Plate onto the DIN Track Mounting Adapter or Front-connecting Socket so that the surface mark of the End Plate faces upwards. Then tighten the screw of the End Plate securely with a screwdriver.

Screw Mounting

- Screw-mount the DIN Track Mounting Adapter or Front-connecting Socket securely after opening screw mounting holes on them.
- When cutting or opening holes on the panel after the Front-connecting Socket is mounted, take proper measures so that the cutting chips will not fall onto the Relay terminals. When cutting or opening holes on the upper part of the panel, mask the Front-connecting Socket properly with a cover.

A High-capacity, High-dielectric-strength, Multi-pole Relay Used Like a Contactor

- Miniature hinge for maximum switching power for motor loads as well as resistive and inductive loads.
- No contact chattering for momentary voltage drops up to 50% of rated voltage.
- Withstanding more than 4 kV between contacts that are different in polarity and between the coil and contacts.
- Flame-resistant materials (UL94V-0-qualifying) used for all insulation material..
- Standard models approved by UL and CSA.



Ordering Information

Mounting type	Contact form	PCB terminals	Screw terminals	Quick-connect terminals
PCB mounting	4PST-NO	G7J-4A-P, G7J-4A-PZ	–	–
	3PST-NO/SPST-NC	G7J-3A1B-P, G7J-3A1B-PZ	–	–
	DPST-NO/DPST-NC	G7J-2A2B-P	–	–
W-bracket (See Note)	4PST-NO	–	G7J-4A-B, G7J-4A-BZ	G7J-4A-T, G7J-4A-TZ
	3PST-NO/SPST-NC	–	G7J-3A1B-B, G7J-3A1B-BZ	G7J-3A1B-T, G7J-3A1B-TZ
	DPST-NO/DPST-NC	–	G7J-2A2B-B	G7J-2A2B-T

Note: These Relays need a W-bracket (sold separately) for mounting.
When ordering specify the voltage.

Example: G7J-4A-P 240 VAC
Rated coil voltage

Model Number Legend

G7J - - -
1 2 3

- 1. Contact Form**
 4A: 4PST-NO
 3A1B: 3PST-NO/SPST-NC
 2A2B: DPST-NO/DPST-NC

- 2. Terminal Shape**
 P: PCB terminals
 B: Screw terminals
 T: Quick-connect terminals
 (#250 terminal)

- 3. Contact Structure**
 Z: Bifurcated contact
 None: Single contact

Note: For bifurcated contact type, output is 1NO (4PST-NO) or 1NC (3PST-NO/SPST-NC).

PCB Terminals

Contact form	Rated voltage (V)	Model
4PST-NO	24, 50, 100 to 120, 200 to 240 VAC	G7J-4A-P
	12, 24, 48, 100 VDC	
3PST-NO/SPST-NC	24, 50, 100 to 120, 200 to 240 VAC	G7J-3A1B-P
	12, 24, 48, 100 VDC	
DPST-NO/DPST-NC	24, 50, 100 to 120, 200 to 240 VAC	G7J-2A2B-P
	12, 24, VDC	

PCB Terminals (Bifurcated Contact)

Contact Form	Rated voltage (V)	Model
4PST-NO	200 to 240 VAC 24 VDC	G7J-4A-PZ
3PST-NO/SPST-NC	12, 24 VDC	G7J-3A1B-PZ

W-bracket Screw Terminals

Contact form	Rated voltage(V)	Model
4PST-NO	24, 50, 100 to 120, 200 to 240 VAC	G7J-4A-B
	12, 24 VDC	
3PST-NO/SPST-NC	24, 50, 100 to 120, 200 to 240 VAC	G7J-3A1B-B
	12, 24 VDC	
DPST-NO/DPST-NC	24, 50, 100 to 120, 200 to 240 V.A.C	G7J-2A2B-B
	12, 24, VDC	

Tab Terminals

Contact form	Rated voltage(V)	Model
4PST-NO	24, 50, 100 to 120, 200 to 240 VAC	G7J-4A-T
	12, 24 VDC	
3PST-NO/SPST-NC	24, 50, 100 to 120, 200 to 240 VAC	G7J-3A1B-B
	12, 24 VDC	
DPST-NO/DPST-NC	24, 50, 100 to 120, 200 to 240 V.A.C	G7J-2A2B-B
	12, 24, VDC	

Screw Terminals (Bifurcated Contact)

Name	Rated voltage (V)	Model
4PST-NO	Under registration	G7J-4A-B
3PST-NO/SPST-NC	24, 50, 100 to 120, 200 to 240 VAC	G7J-3A1B-BZ
	6, 12, 24, 48, 100, 110 VDC	

Tab Terminals (Bifurcated Contact)

Contact form	Rated voltage (V)	Model
4PST-NO	100 to 120, 200 to 240 VAC	G7J-4A-TZ
3PST-NO/SPST-NC	Under registration	G7J-3A1B-TZ

■ Accessories (Order Separately)

Name	Model	Applicable Relay
W-bracket	R99-04 for G5F	G7J-4A-B G7J-3A1B-B G7J-2A2B-B G7J-4A-T G7J-3A1B-T G7J-2A2B-T

Application Examples

- Compressors for air conditioners and heater switching controllers.
- Switching controllers for power tools or motors.
- Lamp controls, motor drivers, and power supply switching controllers in copy machines, facsimile machines, and other office equipment.
- Power controllers for packers or food processing equipment.
- Power controllers for inverters.

Specifications

■ Coil Ratings

	Rated voltage	Rated current voltage	Coil Resistance	Must operate voltage	Must release voltage	Max. voltage	Power consumption
AC	24 VAC	75 mA	–	75% max. of rated voltage	15% min. of rated voltage	110% of rated voltage	Approx. 1.8 to 2.6 VA
	50 VAC	36 mA	–				
	100 to 120 VAC	18 to 21.6 mA	–				
	200 to 240 VAC	9 to 10.8 mA	–				
DC	6 VDC	333 mA	18 Ω		10% min. of rated voltage		Approx. 2.0 W
	12 VDC	167 mA	72 Ω				
	24 VDC	83 mA	288 Ω				
	48 VDC	42 mA	1,150 Ω				
	100 VDC	20 mA	5,000 Ω				

Note: 1. The rated current and coil resistance are measured at a coil temperature of 23°C with tolerances of +15%/–20% for AC rated current and ±15% for DC coil resistance. (The values given for AC rated current apply at 50 Hz or 60 Hz.)

2. Performance characteristic data are measured at a coil temperature of 23°C.

3. The maximum voltage is one that is applicable to the Relay coil at 23°C.

■ Contact Ratings

Item	Resistive load (cos ϕ = 1)	Inductive load (cos ϕ = 0.4)	Resistive load
Contact mechanism	Double break		
Contact material	Ag alloy		
Rated load	NO: 25 A at 220 VAC (24 A at 230 VAC) NC: 8 A at 220 VAC (7.5 A at 230 VAC)		NO: 25 A at 30 VDC NC: 8 A at 30 VDC
Rated carry current	NO: 25 A (1 A) NC: 8 A (1 A)		
Max. switching voltage	250 VAC		125 VDC
Max. switching current	NO: 25 A (1 A) NC: 8 A (1 A)		

Note: The values in parentheses indicate values for a bifurcated contact.

■ Characteristics

Contact resistance (see note 2)	50 m Ω max.
Operate time (see note 3)	50 ms max.
Release time (see note 3)	50 ms max.
Max. operating frequency	Mechanical: 1,800 operations/hr Electrical: 1,800 operations/hr
Insulation resistance (see note 4)	1,000 M Ω min. (at 500 VDC)
Dielectric strength	4,000 VAC, 50/60 Hz for 1 min between coil and contacts 4,000 VAC, 50/60 Hz for 1 min between contacts of different polarity 2,000 VAC, 50/60 Hz for 1 min between contacts of same polarity
Impulse withstand voltage	10,000 V between coil and contact (with 1.2 x 50 μ s impulse wave)
Vibration resistance	Destruction: 10 to 55 to 10 Hz, 0.75 mm single amplitude (1.5 mm double amplitude) Malfunction: NO: 10 to 55 to 10 Hz, 0.75 mm single amplitude (1.5 mm double amplitude); NC: 10 to 26 to 10 Hz, 0.75 mm single amplitude (1.5 mm double amplitude)
Shock resistance	Destruction: 1,000 m/s ² Malfunction: NO: 100 m/s ² NC: 20 m/s ²
Endurance	Mechanical: 1,000,000 operations min. (at 1,800 operations/hr) Electrical: 100,000 operations min. (at 1,800 operations/hr) (see note 5)
Error rate (see note 6)	100 mA at 24 VDC (bifurcated contact: 24 VDC 10 mA)
Ambient temperature	Operating: -25°C to 60°C (with no icing or condensation)
Ambient humidity	Operating: 5% to 85%
Weight	PCB terminal: approx. 140 g Screw terminal: approx. 165 g Quick-connect terminal: approx. 140 g

- Note:
- The above values are all initial values.
 - The contact resistance was measured with 1 A at 5 VDC using the voltage drop method.
 - The operate and the release times were measured with the rated voltage imposed with any contact bounce ignored at an ambient temperature of 23°C.
 - The insulation resistance was measured with a 500-VDC megger applied to the same places as those used for checking the dielectric strength.
 - The electrical endurance was measured at an ambient temperature of 23°C.
 - This value was measured at a switching frequency of 60 operations per minute.

■ Approved by Standards

The G7J satisfies the following international standards. Approval for some international markings and symbols are still pending, however, and information on them will be added when they are approved.

UL (File No. E41643)

CSA (File No. LR35535)

Coil ratings	Contact ratings		Number of test operations
	NO contact	NC contact	
24 to 265 VAC 6 to 110 VDC	NO contact	25 A 277 VAC, Resistive	30,000
		25 A 120 VAC, General Use	
		25 A 277 VAC, General Use	
		1.5 kW 120 VAC, Tungsten	6,000
		1.5 hp 120 VAC	
		3 hp 240/265/277 VAC	
		3-phase 3 hp 240/265/277 VAC	
		3-phase 5 hp 240/265/277 VAC	30,000
		20FLA/120LRA 120 VAC	
		17FLA/102LRA 277 VAC	
	TV-10 120 VAC	25,000	
	25 A 30 VDC, Resistive	30,000	
	1 A 277 VAC, General Use	6,000	
	NC contact	8 A 277 VAC, Resistive	30,000
		8 A 120 VAC, General Use	
		8 A 277 VAC, General Use	
8 A 30 VDC, Resistive			
1 A 277 VAC, General Use		6,000	

Reference

UL approval: UL508 for industrial control devices

UL1950 for information processing equipment including business machines

CSA approval: CSA C22.2 No. 14 for industrial control devices

CSA C22.2 No. 950 for information processing equipment including business machines

VDE (File No. 5381UG)

Model	Coil ratings	Contact ratings	
		NO contact	NC contact
G7J-4A-B(P) (T) (Z) G7J-2A2B(P) (T) G7J-3A1B-B(P) (T) (Z)	6, 12, 24, 48, 100 VDC 24, 50, 100 to 120, 200 to 240 VAC	25 A 240 VAC $\cos\phi = 0.4$ 25 A 240 VAC $\cos\phi = 1$ 25 A 30 VDC L/R ≥ 1 *1 A 240 VAC $\cos\phi = 0.4$	8 A 240 VAC $\cos\phi = 0.4$ 8 A 240 VAC $\cos\phi = 1$ 8 A 30 VDC L/R ≥ 1 *1 A 240 VAC $\cos\phi = 0.4$

Note: Add the suffix “-KM” to the model number when ordering.

*These ratings are bifurcated contact ratings.

Reference

VDE approval: VDE0435 for electromagnetic relays

IEC255 for relays

KEMA (File No. 97.9140.01)

Model	Coil ratings	Contact ratings
		NO contact
G7J-4A-B(P) (T) (Z) G7J-2A2B(P) (T) G7J-3A1B-B(P) (T) (Z)	6, 12, 24, 48, 100 VDC 24, 50, 100 to 120, 200 to 240 VAC	Class AC1: 25 A at 220 VAC 11.5 A at 380 to 480 VAC Class AC3: 11.5 A at 220 VAC and 8.5 A at 380 to 480 VAC Class AC 1 : 1 A at 220 VAC

Note: Add the suffix “-KM” to the model number when ordering.
*This rating is the bifurcated contact ratings.

Reference
KEMA approval: EN60947-4-1 for contacts
IEC947-4-1 for contacts

Engineering Data

Maximum Switching Power

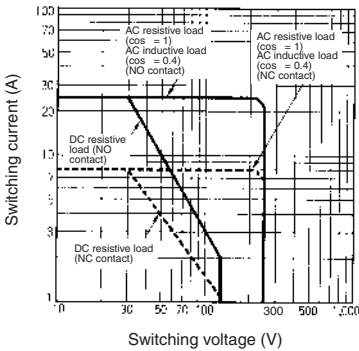

Endurance

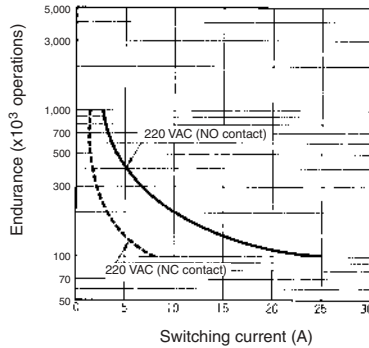

Malfunctioning Shock
G7J-2A2B

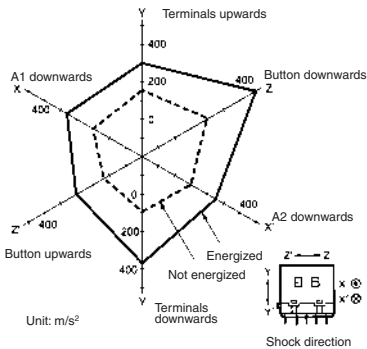

Number of samples: 5
Measurement conditions: Increase and decrease the specified shock gradually imposed in X, Y and Z directions three times each with the Relay energized and not energized to check the shock values that cause the Relay to malfunction.
Criteria: There must not be any contact separation for 1 ms or greater with a shock of 100 m/s² imposed when the coil is energized or with a shock of 20 m/s² when the coil is not energized.

Ambient Temperature vs. Must-operate and Must-release Voltage

G7J 100 to 120 VAC

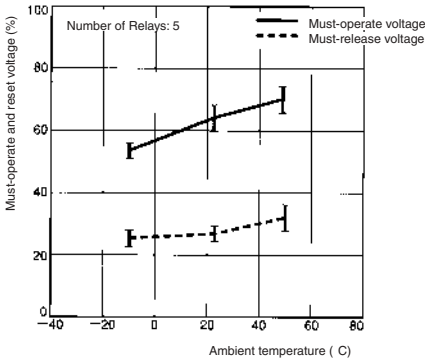

Ambient Temperature vs. Coil Temperature Rise

G7J-4A 100 to 120 VAC

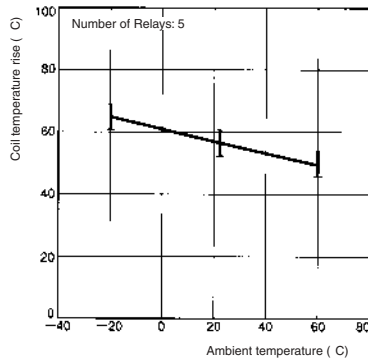

G7J 24 VDC

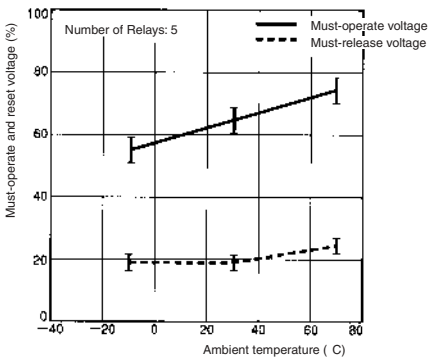

G7J-4A 24 VDC

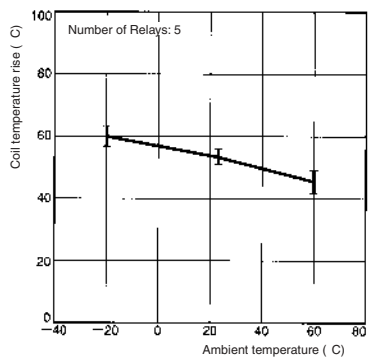

Motor Load

Item	G7J-4A-P, G7J-3A1B-P, G7J-4A-B, G7J-3A1B-B, G7J-4A-T, G7J-3A1B-T
Load	3φ, 220 VAC, 2.7 kW (with an inrush current of 78 A and a breaking current of 13 A)
Endurance	Electrical: 100,000 operations min.

Dimensions

Note: All units are in millimeters unless otherwise indicated.

Screw Terminals with W-bracket

G7J-4A-B, G7J-4A-BZ, G7J-3A1B-B, G7J-3A1B-BZ, G7J-2A2B-B

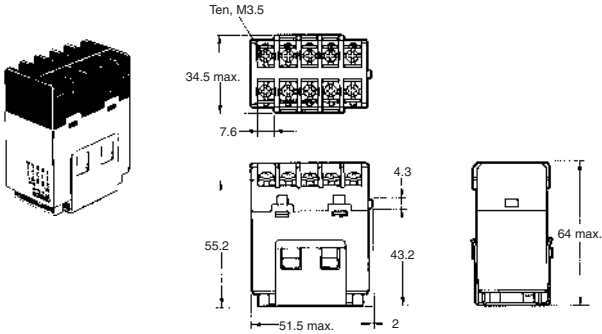

Mounting Holes

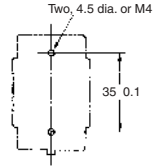

Quick-connect Terminals with W-bracket

G7J-4A-T, G7J-4A-TZ, G7J-3A1B-T, G7J-3A1B-TZ, G7J-2A2B-T

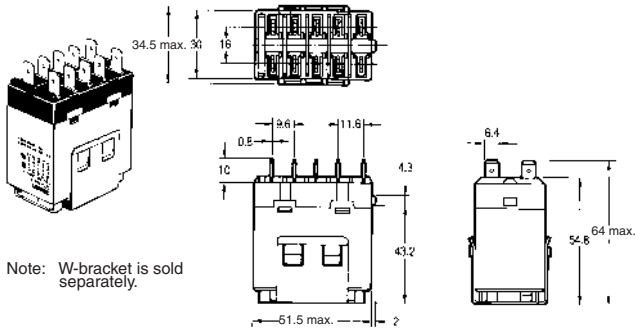

Mounting Holes

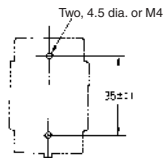

Note: W-bracket is sold separately.

PCB Terminals with PCB Mounting

G7J-4A-P, G7J-4A-PZ, G7J-3A1B-P, G7J-3A1B-PZ, G7J-2A2B-P

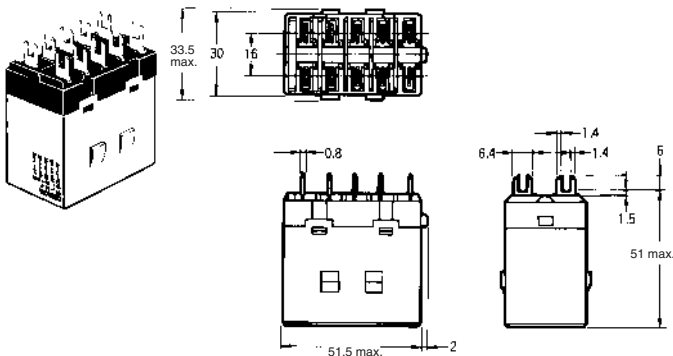

Mounting Dimensions

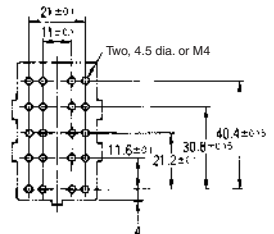

Terminal Arrangement/Internal Connections

G7J-4A-P(B) (T) (Z)

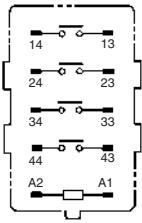

G7J-3A1B-P(B) (T) (Z)

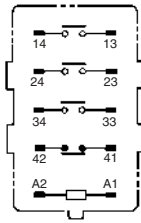

The coil has no polarity.

G7J-2A2B-P(B) (T)

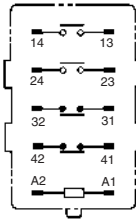

Note: Terminals 43 and 44 of the G7J-4A-P(B)(T)(Z) and contacts 41 and 42 of the G7J-3A1B-P(B)(T)(Z) are bifurcated contacts.

Accessories (Order Separately)

R99-04 W-bracket (for G5F)

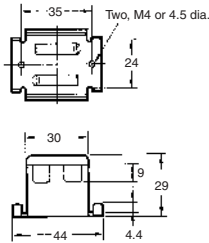
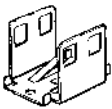

Mounting Holes

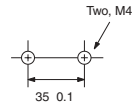

Precautions

Installation

PCB Terminal-equipped Relays weigh approximately 140 g. Be sure that the PCB is strong enough to support them. We recommend dual-side through-hole PCBs to reduce solder cracking from heat stress.

Mount the G7J with its test button facing downwards. The Relay may malfunction due to shock if the test button faces upwards. Be careful not to press the test button by mistake because the contacts will go ON if the test button is pressed.

Be sure to use the test button for test purposes only.

The test button is used for Relay circuit tests, such as a circuit continuity test. Do not attempt to switch the load with the test button.

Minute Loads

The G7J is used for switching power loads, such as motor, transformer, solenoid, lamp, and heater loads. Do not use the G7J for switching minute loads, such as signals. Use a Relay with a bifurcated contact construction for switching minute loads, in which case, however, only SPST-NO or SPST-NC output is obtained.

Soldering PCB Terminals

Be sure to solder the PCB terminals manually only. In the case of automatic soldering, some flux may stick to the test button and the G7J. As a result, the G7J may malfunction.

The G7J is not of enclosed construction. Therefore, do not wash the G7J with water or any detergent.

Connecting

Refer to the following diagram when connecting a wire with a screw terminal to the G7J.

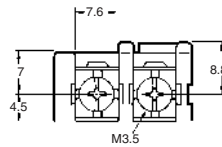

Allow suitable slack on leads when wiring, and do not subject the terminals to excessive force.

Tightening torque: 0.98 N • m

Do not impose excessive external force on the G7J in the horizontal or vertical directions when inserting the G7J to the Faston receptacle or pulling the G7J out from the Faston receptacle. Do not attempt to insert or pull out more than one G7J Unit together.

Do not solder the tab terminals.

Terminal	Receptacle	Housing
#250 terminal (6.35 mm in width)	AMP170333-1 (170327-1) AMP170334-1 (170328-1) AMP170335-1 (170329-1)	AMP172076-1: natural AMP172076-4: yellow AMP172076-5: green AMP172076-6: blue

Note: Numbers in parentheses are for air feed use.

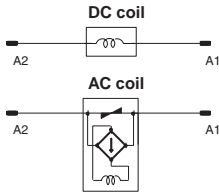
OPERATING COIL**Internal Connections of Coils**

If a transistor drives the G7J, check the leakage current, and connect a bleeder resistor if necessary.

The AC coil is provided with a built-in full-wave rectifier. If a triac, such as an SSR, drives the G7J, the G7J may not release. Be sure to perform a trial operation with the G7J and the triac before applying them to actual use.

Slim Relays with Forcibly Guided Contacts Conforming to EN Standards

- EN50205 Class A, approved by VDE.
- Ideal for use in safety circuits in production machinery.
- Four-pole and six-pole Relays are available.
- The Relay’s terminal arrangement simplifies PWB pattern design.
- Reinforced insulation between inputs and outputs. Reinforced insulation between some poles.
- UL, CSA approval.
- CE marking.



Ordering Information

Relays with Forcibly Guided Contacts

Type	Sealing	Poles	Contacts	Rated voltage	Model
Standard	Flux-tight	4 poles	3PST-NO, SPST-NC	24 VDC	G7SA-3A1B
			DPST-NO, DPST-NC		G7SA-2A2B
		6 poles	5PST-NO, SPST-NC		G7SA-5A1B
			4PST-NO, DPST-NC		G7SA-4A2B
			3PST-NO, 3PST-NC		G7SA-3A3B

Sockets

Type	Sealing	LED indicator	Poles	Rated voltage	Model
Track-mounting	Track mounting and screw mounting possible	No	4 poles	---	P7SA-10F
			6 poles		P7SA-14F
		Yes	4 poles	24 VDC	P7SA-10F-ND
			6 poles		P7SA-14F-ND
Back-mounting	PCB terminals	No	4 poles	---	P7SA-10P
			6 poles		P7SA-14P

Model Number Legend

G7SA-□A□B
1 2

1. NO Contact Poles
- 2: DPST-NO
 - 3: 3PST-NO
 - 4: 4PST-NO
 - 5: 5PST-NO

2. NC Contact Poles
- 1: SPST-NC
 - 2: DPST-NC
 - 3: 3PST-NC

Ratings

■ Coil

Rated voltage	Rated current	Coil resistance	Must-operate voltage	Must-release voltage	Max. voltage	Power consumption
24 VDC	4 poles: 15 mA 6 poles: 20.8 mA	4 poles: 1,600 Ω 6 poles: 1,152 Ω	75% max. (V)	10% min. (V)	110% (V)	4 poles: Approx. 360 mW 6 poles: Approx. 500 mW

- Note:** 1. The rated current and coil resistance are measured at a coil temperature of 23°C with tolerances of ±15%.
 2. Performance characteristics are based on a coil temperature of 23°C.
 3. The value given for the maximum voltage is for voltages applied instantaneously to the Relay coil (at an ambient temperature of 23°C) and not continuously.

■ Contacts

Load	Resistive load (cos φ =1)
Rated load	6 A at 250 VAC, 6 A at 30 VDC
Rated carry current	6 A
Max. switching voltage	250 VAC, 125 VDC
Max. switching current	6 A
Max. switching capacity (reference value)	1,500 VA, 180 W

Characteristics

■ Sockets

Model	Continuous current	Dielectric strength	Insulation resistance
P7SA-14□	6 A (see note 1)	2,500 VAC for 1 min. between poles	100 MΩ min. (see note 2)

- Note:** 1. If the P7SA-1□F is used between 55 and 85°C, reduce the continuous current (from 6 A) by 0.1 A for every degree.
 2. Measurement conditions: Measurement of the same points as for the dielectric strength at 500 VDC.
 3. When using the P7SA-1□F-ND at 24 VDC, use at an ambient operating temperature from -25 to 55°C.

■ Relays with Forcibly Guided Contacts

Contact resistance		100 mΩ max. (The contact resistance was measured with 1 A at 5 VDC using the voltage-drop method.)
Operating time (see note 2)		20 ms max.
Response time (see note 2)		10 ms max. (The response time is the time it takes for the normally open contacts to open after the coil voltage is turned OFF.)
Release time (see note 2)		20 ms max.
Maximum operating frequency	Mechanical	36,000 operations/hr
	Rated load	1,800 operations/hr
Insulation resistance		100 MΩ min. (at 500 VDC) (The insulation resistance was measured with a 500-VDC megger at the same places that the dielectric strength was measured.)
Dielectric strength (see notes 3, 4)		Between coil contacts/different poles: 4,000 VAC, 50/60 Hz for 1 min (2,500 VAC between poles 3-4 in 4-pole Relays or poles 3-5, 4-6, and 5-6 in 6-pole Relays.) Between contacts of same polarity: 1,500 VAC, 50/60 Hz for 1 min
Vibration resistance		10 to 55 Hz, 1.5-mm double amplitude
Shock resistance	Destruction	1,000 m/s ²
	Malfunction	100 m/s ²
Durability	Mechanical	10,000,000 operations min. (at approx. 36,000 operations/hr)
	Electrical	100,000 operations min. (at the rated load and approx. 1,800 operations/hr)
Min. permissible load (see note 5) (reference value)		5 VDC, 1 mA
Ambient temperature (see note 6)		Operating: -40°C to 85°C (with no icing or condensation) Storage: -40°C to 85°C (with no icing or condensation)

Ambient humidity	Operating: 35% to 85% Storage: 35% to 85%
Weight	4 poles: Approx. 22 g 6 poles: Approx. 25 g
Approved standards	EN61810-1 (IEC61810-1), EN50205, UL508, CSA22.2 No. 14

- Note:** 1. The values listed above are initial values.
 2. These times were measured at the rated voltage and an ambient temperature of 23°C. Contact bounce time is not included.
 3. Pole 3 refers to terminals 31–32 or 33–34, pole 4 refers to terminals 43–44, pole 5 refers to terminals 53–54, and pole 6 refers to terminals 63–64.
 4. When using a P7SA Socket, the dielectric strength between coil contacts/different poles is 2,500 VAC, 50/60 Hz for 1 min.
 5. Min. permissible load is for a switching frequency of 300 operations/min.
 6. When operating at a temperature between 70°C and 85°C, reduce the rated carry current (6 A at 70°C or less) by 0.1 A for each degree above 70°C.

Dimensions

Note: All units are in millimeters unless otherwise indicated.

■ Relays with Forcibly Guided Contacts

G7SA-3A1B
G7SA-2A2B

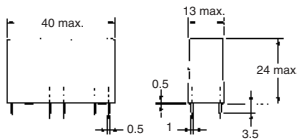
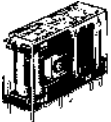

**Terminal Arrangement/
Internal Connection Diagram
(Bottom View)**

G7SA-3A1B

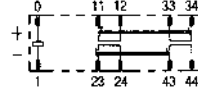

**Printed Circuit Board
Design Diagram
(Bottom View)**

(0.1 tolerance)

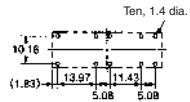

G7SA-2A2B

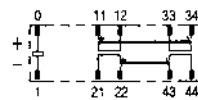

Note: Terminals 23-24, 33-34, and 43-44 are normally open. Terminals 11-12 and 21-22 are normally closed.

G7SA-5A1B
G7SA-4A2B
G7SA-3A3B

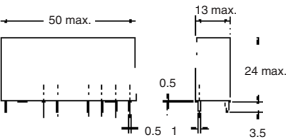
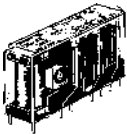

**Terminal Arrangement/
Internal Connection Diagram
(Bottom View)**

G7SA-5A1B

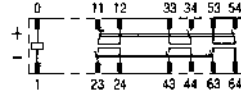

**Printed Circuit Board
Design Diagram
(Bottom View)**

(0.1 tolerance)

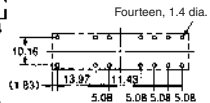

G7SA-4A2B



Note: Terminals 23-24, 33-34, 53-54, and 63-64 are normally open. Terminals 11-12, 21-22, and 31-32 are normally closed.

G7SA-3A3B



■ Sockets

Track-mounting Socket

P7SA-10F, P7SA-10F-ND

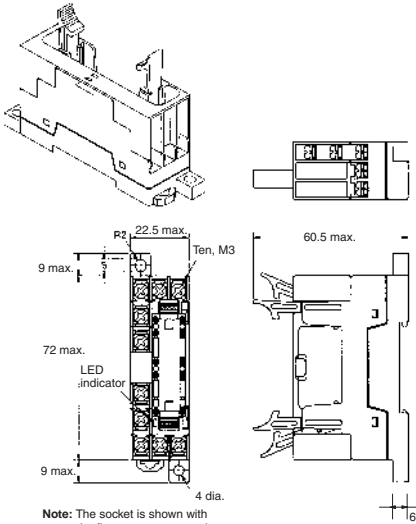

Note: Only the -ND Sockets have LED indicators.

Track-mounting Socket

P7SA-14F, P7SA-14F-ND

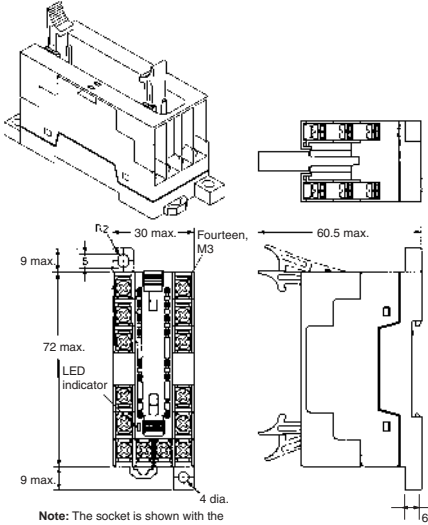

Note: Only the -ND Sockets have LED indicators.

Terminal Installation/Internal Connection Diagram (Top View)

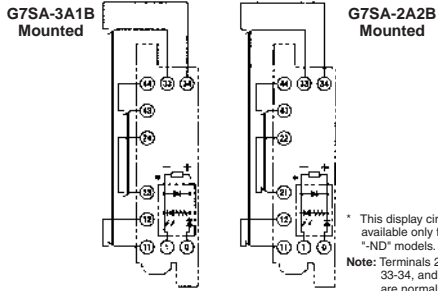

Mounting Hole Placement Diagram (Top View)

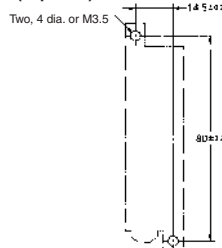

Terminal Arrangement/Internal Connection Diagram (Top View)

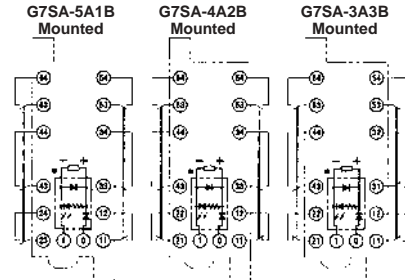

Mounting Hole Placement Diagram (Top View)

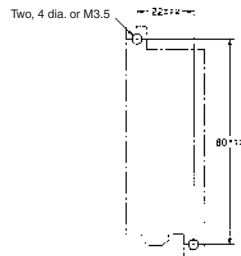

* This display circuit is available only for "-ND" models. Note: Terminals 23-24, 33-34, 43-44, 53-54, and 63-64 are normally open. Terminals 11-12, 21-22, and 31-32 are normally closed.

■ P7SA-10P Back-mounting Socket (for PCB)

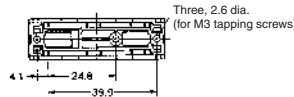
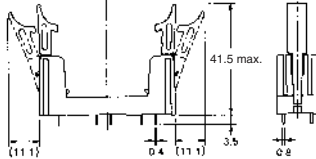
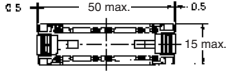
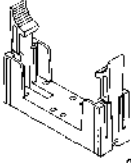

Terminal Arrangement/Internal Connection Diagram (Bottom View)

Mounting Hole Placement (Bottom View) (0.1 tolerance)

G7SA-3A1B Mounted

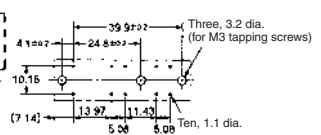
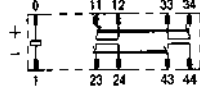

Note: Terminals 23-24, 33-34, and 43-44 are normally open. Terminals 11-12 and 21-22 are normally closed.

■ P7SA-14P Back-mounting Socket (for PCB)

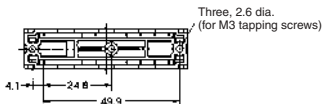
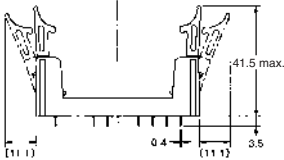
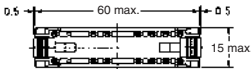
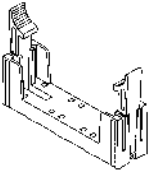

Terminal Arrangement/Internal Connection Diagram (Bottom View)

Mounting Hole Placement (Bottom View) (0.1 tolerance)

G7SA-5A1B Mounted

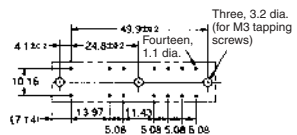

G7SA-4A2B Mounted



Note: Terminals 23-24, 33-34, 43-44, 53-54, and 63-64 are normally open, Terminals 11-12, 21-22, and 31-32 are normally closed.

G7SA-3A3B Mounted



Precautions



CAUTION

Do not touch the terminal area of the Relays or the socket terminal area (charged area) while power is ON. Electric shock will result

Relays with Forcibly Guided Contacts

A Relay with Forcibly Guided Contacts is a Relay with which a safety category circuit can be configured.

Wiring

Use one of the following wires to connect to the P7SA-10F/10F-ND/14F/14F-ND.

- Stranded wire: 0.75 to 1.5 mm²
- Solid wire: 1.0 to 1.5 mm²

Tighten each screw of the P7SA-10F/10F-ND/14F/14F-ND to a torque of 0.98 N·m securely.

Wire the terminals correctly with no mistakes in coil polarity, otherwise the G7SA will not operate.

Cleaning

The G7SA is not of enclosed construction. Therefore, do not wash the G7SA with water or detergent.

Forcibly Guided Contacts (from EN50205)

If an NO contact becomes welded, all NC contacts will maintain a minimum distance of 0.5 mm when the coil is not energized. Likewise if an NC contact becomes welded, all NO contacts will maintain a minimum distance of 0.5 mm when the coil is energized.

Correct Use

Relays with Forcibly Guided Contacts

While the Relay with Forcibly Guided Contacts has the previously described forcibly guided contact structure, it is basically the same as an ordinary relay in other respects. Rather than serving to prevent malfunctions, the forcibly guided contact structure enables another circuit to detect the condition following a contact weld or other malfunction. Accordingly, when a contact weld occurs in a Relay with Forcibly Guided Contacts, depending on the circuit configuration, the power may not be interrupted, leaving the Relay in a potentially dangerous condition (as shown in Fig. 1).

To configure the power control circuit to interrupt the power when a contact weld or other malfunction occurs, and to prevent restarting until the problem has been eliminated, add another Relay with Forcibly Guided Contacts or similar Relay in combination to provide redundancy and a self-monitoring function to the circuit (as shown in Fig. 2).

The G9S/G9SA Safety Relay Unit, which combines Relays such as the Relay with Forcibly Guided Contacts in order to provide the above-described functions, is available for this purpose. By connecting a contactor with appropriate input and output to the Safety Relay Unit, the circuit can be equipped with redundancy and a self-monitoring function.

