

Safety Mat UMA Series

Easy-to-install safety mat with advanced features

- 1 and 2 cable types
- Meets EN ISO 13849-1 (PLd/Safety Category 3) and EN ISO 13856-1
- Can be used with MC3 Safety Mat Controller or NX Safety Controller
- Complies with North American safety standards including ANSI/RIA 15.06



Model Number Structure

U M A - - -

1 2 3 4 5

1. Measurement Unit

None: Inch
M: mm

2. Color

None: Black
Y: Yellow

3. Safety Mat Dimension A

4. Safety Mat Dimension B

5. Number of Cables

1: 1 cable (4-wire type)
2: 2 cables (2-wire type)

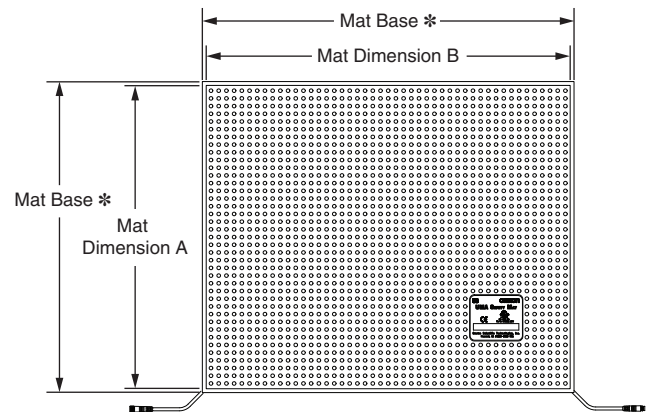

* Refer to *Mat Dimensions* for the dimensions of the mat base.

UMA

Ordering Information

Safety Mats

1-cable Mats

Appearance	Dimensions		Black	Yellow
	A (mm)	B (mm)	Model	Model
	300	300	UMMA-0300-0300-1	UMMYA-0300-0300-1
	400	400	UMMA-0400-0400-1	UMMYA-0400-0400-1
	500	250	UMMA-0500-0250-1	UMMYA-0500-0250-1
	500	400	UMMA-0500-0400-1	UMMYA-0500-0400-1
	500	500	UMMA-0500-0500-1	UMMYA-0500-0500-1
	500	1500	UMMA-0500-1500-1	UMMYA-0500-1500-1
	600	400	UMMA-0600-0400-1	UMMYA-0600-0400-1
	750	250	UMMA-0750-0250-1	UMMYA-0750-0250-1
	750	500	UMMA-0750-0500-1	UMMYA-0750-0500-1
	750	750	UMMA-0750-0750-1	UMMYA-0750-0750-1
	750	1500	UMMA-0750-1500-1	UMMYA-0750-1500-1
	1000	500	UMMA-1000-0500-1	UMMYA-1000-0500-1
	1000	750	UMMA-1000-0750-1	UMMYA-1000-0750-1
	1000	1000	UMMA-1000-1000-1	UMMYA-1000-1000-1
	1000	1250	UMMA-1000-1250-1	UMMYA-1000-1250-1
	1000	1500	UMMA-1000-1500-1	UMMYA-1000-1500-1

2-cable Mats

Appearance	Dimensions		Black	Yellow
	A (mm)	B (mm)	Model	Model
	300	300	UMMA-0300-0300-2	UMMYA-0300-0300-2
	400	400	UMMA-0400-0400-2	UMMYA-0400-0400-2
	500	250	UMMA-0500-0250-2	UMMYA-0500-0250-2
	500	400	UMMA-0500-0400-2	UMMYA-0500-0400-2
	500	500	UMMA-0500-0500-2	UMMYA-0500-0500-2
	500	1500	UMMA-0500-1500-2	UMMYA-0500-1500-2
	600	400	UMMA-0600-0400-2	UMMYA-0600-0400-2
	750	250	UMMA-0750-0250-2	UMMYA-0750-0250-2
	750	500	UMMA-0750-0500-2	UMMYA-0750-0500-2
	750	750	UMMA-0750-0750-2	UMMYA-0750-0750-2
	750	1500	UMMA-0750-1500-2	UMMYA-0750-1500-2
	1000	500	UMMA-1000-0500-2	UMMYA-1000-0500-2
	1000	750	UMMA-1000-0750-2	UMMYA-1000-0750-2
	1000	1000	UMMA-1000-1000-2	UMMYA-1000-1000-2
	1000	1250	UMMA-1000-1250-2	UMMYA-1000-1250-2
	1000	1500	UMMA-1000-1500-2	UMMYA-1000-1500-2

Trims

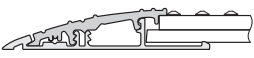
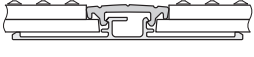
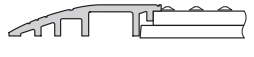
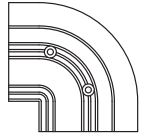
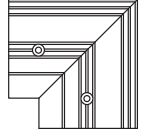
Appearance	Name	Model	Remarks
	Ramp Trim with Yellow PVC Cover (1.22 m)	UMRT4	Installed on the perimeter of the Safety Mat. Each Trim is composed of two parts, an aluminum base and a PVC Cover. Possible to install cables inside.
	Ramp Trim with Yellow PVC Cover (2.44 m)	UMRT8	
	Joining Trim (1.22 m)	UMJS4	The Joining Trims join the Safety Mats when two or more Safety Mats are being combined. In addition to joining the Safety Mats, the Joining Trims preserve the Safety Mat's sensitivity at the joints.
	Joining Trim (2.44 m)	UMJS8	
	Aluminum Ramp Trim (2.44 m)	UMAL	Installed on the perimeter of the Safety Mat.
	Molded Outside Corner	UMOC	Installed at the outside corners of the Safety Mat combining with Ramp Trims with Yellow PVC Cover.
	Molded Inside Corner	UMIC	Installed at the inside corners when two or more Safety Mats combining with Ramp Trims with Yellow PVC Cover are being combined.

Note: 12 screws (No. 8 x 32 mm) and 12 anchors are bundled with a Trim.

Trim Kits (Not Including Safety Mat)

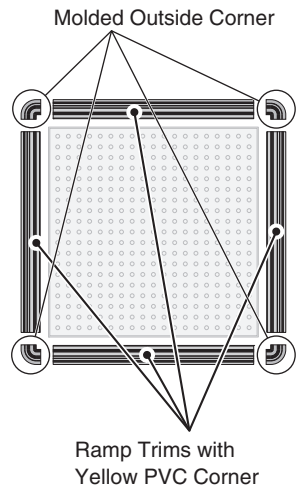
Applicable Safety Mat		Trim Kit model	Remarks
Black	Yellow		
UMMA-0300-0300-□	UMMYA-0300-0300-□	MTKCA-0300-0300	A set of Molded Outside Corners and Trims <ul style="list-style-type: none"> • 4 UMOC Molded Outside Corners • 4 Ramp Trims with Yellow PVC Corners that fit the mat dimensions A and B 
UMMA-0400-0400-□	UMMYA-0400-0400-□	MTKCA-0400-0400	
UMMA-0500-0250-□	UMMYA-0500-0250-□	MTKCA-0500-0250	
UMMA-0500-0400-□	UMMYA-0500-0400-□	MTKCA-0500-0400	
UMMA-0500-0500-□	UMMYA-0500-0500-□	MTKCA-0500-0500	
UMMA-0500-1500-□	UMMYA-0500-1500-□	MTKCA-0500-1500	
UMMA-0600-0400-□	UMMYA-0600-0400-□	MTKCA-0600-0400	
UMMA-0750-0250-□	UMMYA-0750-0250-□	MTKCA-0750-0250	
UMMA-0750-0500-□	UMMYA-0750-0500-□	MTKCA-0750-0500	
UMMA-0750-0750-□	UMMYA-0750-0750-□	MTKCA-0750-0750	
UMMA-0750-1500-□	UMMYA-0750-1500-□	MTKCA-0750-1500	
UMMA-1000-0500-□	UMMYA-1000-0500-□	MTKCA-1000-0500	
UMMA-1000-0750-□	UMMYA-1000-0750-□	MTKCA-1000-0750	
UMMA-1000-1000-□	UMMYA-1000-1000-□	MTKCA-1000-1000	
UMMA-1000-1250-□	UMMYA-1000-1250-□	MTKCA-1000-1250	
UMMA-1000-1500-□	UMMYA-1000-1500-□	MTKCA-1000-1500	

Note: 1. Put 1 in the box (□) in the model number for 1-cable Mat or 2 for 2-cable Mat.
 2. 24 screws (No. 8 x 32 mm) and 24 anchors are bundled with a Trim Kit.

Safety Mat Controller



Appearance	Safety outputs	Auxiliary outputs	Rated voltage	Terminal block type	Model
	SPDT-NO	SPDT-NC	24 VDC	Screw terminals	MC3

Accessories

Using with 1-cable Mats

Connecting a 1-cable Mat to a MC3 Safety Mat Controller or NX-series Safety Controller.



Cables

Appearance	Name	Length	Remarks	Model
	Single Connector Cable	2 m	Single connector cable to connect a 1-cable Mat (UM□□A-□-□-1) to a Controller. M8, 4-socket	UMA-CBL-4PCF-M8-02M
		5 m		UMA-CBL-4PCF-M8-05M
		10 m		UMA-CBL-4PCF-M8-10M
	Male-Female Extension Cable	2 m	Extension cable to connect a 1-cable Mat (UM□□A-□-□-1) to a Controller. M8, 4-pin	UMA-CBL-4PMF-M8-02M
		5 m		UMA-CBL-4PMF-M8-05M
		10 m		UMA-CBL-4PMF-M8-10M

Using with 2-cable Mats



Connecting a 2-cable Mat to a MC3 Safety Mat Controller or NX-series Safety Controller.

Cables

Appearance	Name	Length	Remarks	Model
	Single Connector Cable	2 m	Single connector cable to connect a 2-cable Mat (UM□□A-□-□-2) to a Controller. M8,3-socket	UMA-CBL-3PCF-M8-02M
		5 m		UMA-CBL-3PCF-M8-05M
		10 m		UMA-CBL-3PCF-M8-10M
	Male-Female Extension Cable	2 m	Extension cable to connect a 2-cable Mat (UM□□A-□-□-2) to a Controller. M8,3-pin	UMA-CBL-3PMF-M8-02M
		5 m		UMA-CBL-3PMF-M8-05M
		10 m		UMA-CBL-3PMF-M8-10M

Male-Male Extension Cable and Female-Female Extension Cable

Refer to *Connection Examples of Safety Mat and Controller* on page 7 for details on how to connect.

Appearance	Name	Length	Remarks	Model
	M8, 3-pin Male to Male Extension Cable	0.15 m	To be used to connect the connector sockets of 2-cable UMA Safety Mat together.	UMA-CBL-3PMM-M8-0.15M
	M8, 3-pin Female to Female Extension Cable	0.15 m	To be used to connect the connector plugs of 2-cable UMA Safety Mat together.	UMA-CBL-3PFF-M8-0.15M

Specifications

Safety Mat

Detection Method	Pressure sensitive
Mat Type	Normally open SPST, four-wire (1-cable type) or two-wire (2-cable type) available
Mat Electrical Rating	20.4 V to 28.8 V
Activation Force	300 N min. to 80 mm dia. test piece
Maximum Load	2,000 N to 80 mm dia. test piece 1,862 kPa (270 lbs/in. ²) (rolling load (stationary))
Response Time	50 ms max.
Mechanical Durability	1 x 10 ⁶ operations min.
Mat Exit Cable	Model No. ending '-1': 1 exit cable, M8 4-pin cable, 4 conductors, 22 AWG, male Model No. ending '-2': 2 exit cables, M8 3-pin cable, 2 conductors, 22 AWG, 1 male and 1 female
Ambient operating temperature	-10 to 55°C (14 to 131°F) (with no icing or condensation)
Ambient storage temperature	-10 to 55°C (14 to 131°F) (with no icing or condensation)
Ambient operating humidity	0 to 95% RH
Degree of protection	IP65
Material (Mat cover)	Polyurethane
Weight	Approx. 25 kg/m ²

Safety Mat Controller

Ratings

Item	Model	MC3
Power voltage		24 VDC
Operating voltage range		-15% to +15% of rated supply voltage
Power consumption *		3 W max.
Rated load		6 A at 230 VAC/6 A at 24 VDC (resistive load) 5 A at 230 VAC (AC15)/2 A at 24 VDC (DC13) (inductive load)
Maximum rated voltage		250 VAC/24 VDC
Rated carry current		6 A
Maximum switching capacity		1,500 VA

* Power consumption of loads is not included.

Characteristics

Item	Model	MC3
Response time		30 ms max.
Safety input		Mat can be connected in series (Connectable number: 12 max.) The external impedance must be 8 Ω or less between M11 and M21 and between M12 and M22.
Safety output		SPDT-NO
Auxiliary output		SPDT-NC
Insulation resistance		20 MΩ min. (at 500 VDC)
Dielectric strength	Between different poles of outputs	1,800 VAC, 50/60 Hz for 1 sec.
	Between power supply and output	
Vibration resistance		Malfunction: 10 to 55 Hz, 0.15 mm single amplitude
Mechanical shock resistance		Malfunction: 98 m/s ²
Durability	Mechanical	10,000,000 cycles min.
	Electrical	100,000 cycles min. (rated load, switching frequency: 360 cycles/hour)
Ambient operating temperature		0 to 55°C (with no icing or condensation)
Ambient operating humidity		0% to 90% RH
Degree of protection		IP20
Terminal tightening torque		0.5 N·m
Weight		Approx. 360 g

Approvals

Conforming to Standards	EN ISO13856-1:2013, EN ISO13849-1:2015, ANSI/UL 508, CSA C22.2 No. 14
Performance level (PL)/ safety category *	PL d/safety category 3 (EN ISO 13849-1:2015)
PFHd *	4.8x10 ⁻⁸

* Applicable to integrated systems of UMA Safety Mats and MC3 Safety Mat Controller.

UMA

Installation

Using Trim Pieces

Ramp Trim with Yellow PVC Cover: UMRT4/UMRT8

Secures the edges of the Safety Mats to the floor.
It is composed of two parts with an aluminum base and a PVC Cover.

Joining Trim: UMJS4/UMJS8

The Joining Trims join the Safety Mats when two or more Safety Mats are being combined.

In addition to joining the Safety Mats, the Joining Trims preserve the Safety Mat's sensitivity at the joints.

Aluminum Ramp Trim: UMAL

Secures the edges of the Safety Mat to the floor.
The Aluminum Ramp Trim is hollow, so cable can be routed through it.

Molded Outside Corner: UMOC

Used together with the Ramp Trim with Yellow PVC Cover (UMRT4/UMRT8) to secure the external corners of the Safety Mats to the floor.

Molded Inside Corner: UMIC

Used together with the Ramp Trim with Yellow PVC Cover (UMRT4/UMRT8) to secure the internal corners of the Safety Mats to the floor.

Note: 1. The Aluminum Ramp Trim or Ramp Trim with Yellow PVC Cover must be cut to fit the size of the Safety Mats being used.

Furthermore, when the Safety Mat's wiring is being routed through the Aluminum Ramp Trim or Ramp Trim with Yellow PVC Cover, it will be necessary to cut or notch the Aluminum Ramp Trim or Ramp Trim with Yellow PVC Cover for cable access.

Refer to *UMA Safety Mat User Manual* (Man. No. Z375-E1) for details on cutting or notching the Aluminum Ramp Trim or Ramp Trim with Yellow PVC Cover.

- The Joining Trim must be cut to fit the size of the Safety Mats being used.
- The Ramp Trim with Yellow PVC Cover and Molded Corner must be anchored to the floor to secure the Safety Mats. It is also necessary to drill holes in the Trim and Molded Corner and anchoring it to the floor.

Safety Mat Configuration

The Safety Mats are secured by anchoring the Ramp Trim with Yellow PVC Cover and Molded Corner to the floor.

Before ordering, confirm the number of Ramp Trim with Yellow PVC Cover and Molded Corner pieces that will be needed.

Example 1: Using a Single Safety Mat

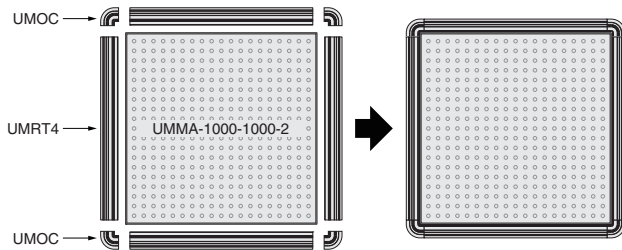

In this case, the perimeter of the Safety Mat is about 4 m and the following pieces are required:

- The example above consists of the following components:
- UMYM5-1000-1000 Safety Mat : 1 piece
 - UMRT4 Ramp Trim with Yellow PVC Cover (1.22 m) : 4 pieces
 - UMOC Molded Outside Corner : 4 pieces

Example 2: Using three Safety Mats

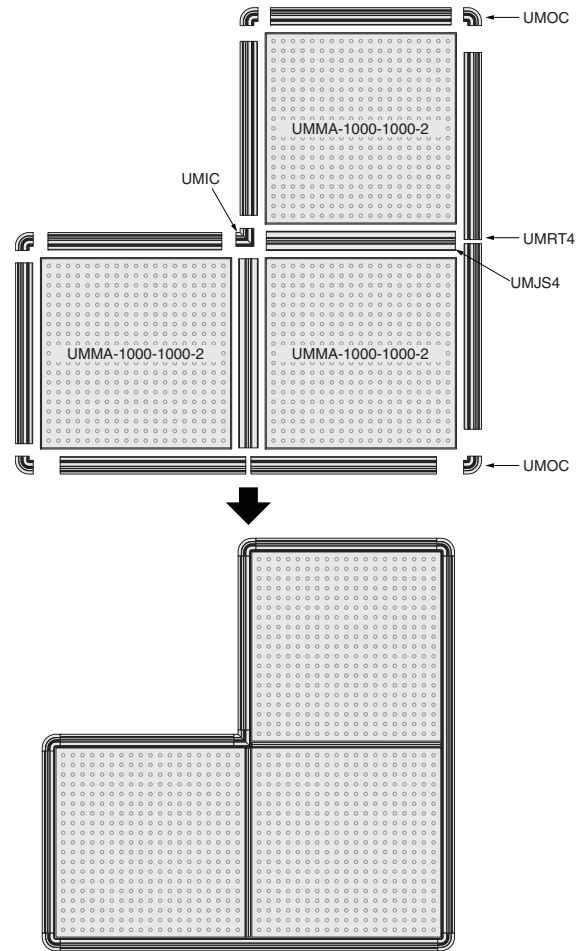

In this case, the perimeter of the Safety Mat is about 8 m, the joint between the Safety Mats is 2-m long, and the following pieces are required:

The example above consists of the following components:

- UMYM5-1000-1000 Safety Mat : 3 pieces
- UMRT4 Ramp Trim with Yellow PVC Cover (1.22 m) : 8 pieces
- UMJS4 Joining Trim (1.22 m) : 2 pieces
- UMOC Molded Outside Corner : 5 pieces
- UMIC Molded Inside Corner : 1 piece

Connection Examples of Safety Mat and Controller Using a Single Safety Mat

Connecting a 1-cable Mat (UM□□A-□-□-1) to a MC3 Safety Mat Controller.

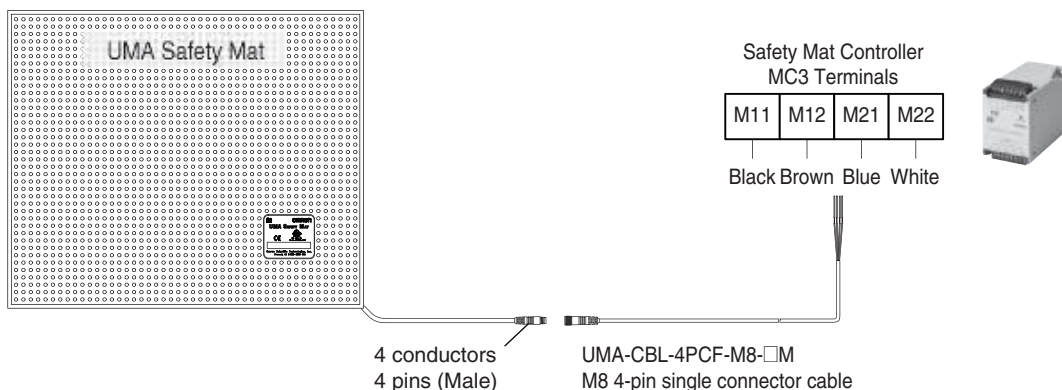

Using Multiple Safety Mats

Connecting three 2-cable Mats (UM□□A-□-□-2) to a MC3 Safety Mat Controller.

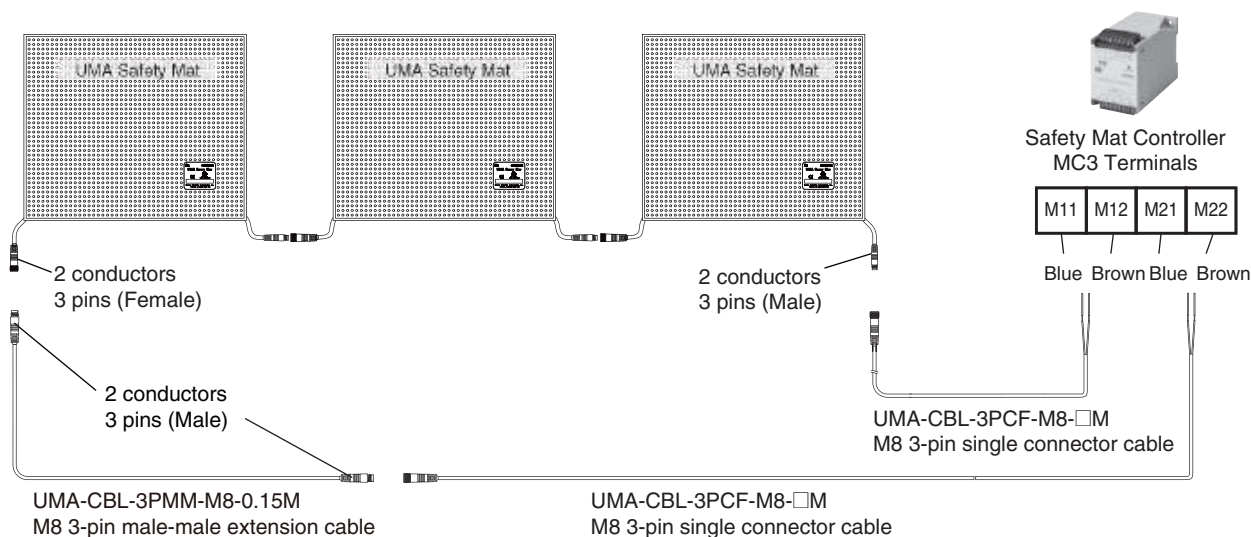

- Note:**
1. Total cable length up to 100 m. Up to 12 Safety Mats connectable (up to 10 m² in total).
 2. The required accessories vary depending on the mat configuration and layout.

UMA

Connections

Internal Connection

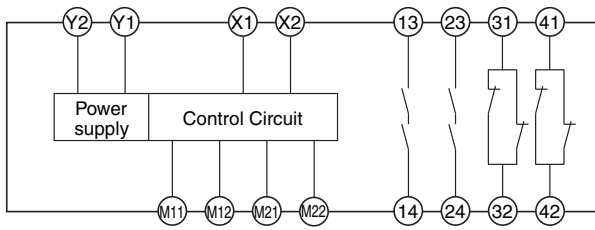

Wiring of Inputs and Outputs

Signal name	Terminal name	Description of operation	Wiring
Power supply input	Y1, Y2	Power supply input terminals for MC3 Connect the power source to the Y1 and Y2 terminals.	Connect the power supply plus (24 VDC) to the Y1 terminal. Connect the power supply minus (GND) to the Y2 terminal.
Safety Mat input	M11, M12, M21, M22	To turn ON safety outputs, all the connected safety mats must have no load. Otherwise, the safety outputs will NOT turn ON.	
Reset input	X1, X2	The Safety Outputs can be turned ON only after the connection between X1 and X2 closes and then opens. If the connection between X1 and X2 does not close and open, the Safety Outputs will not turn ON.	Manual Reset Mode
		The normal operation can be made if the connection between X1 and X2 is open.	Auto Reset Mode
Safety output	13-14, 23-24	The Safety Outputs are turned ON and OFF according to the status of the Safety Mat inputs and the reset input.	Keep these outputs Open when NOT used.
Auxiliary output	31-32, 41-42	Turns ON/OFF according to the state of the opposite logic to the safety outputs.	Keep these outputs Open when NOT used.

Changing the Reset Mode

You can select either the Auto Reset Mode or the Manual Reset Mode with the MC3 Controller.
Remove the terminal block from the top of the MC3 Controller to expose three yellow jumpers. Set the jumps as required by system specifications.

Auto Reset Mode (Factory Setting)

Leave all three jumpers connected.

Manual Reset Mode

Remove all three jumpers.

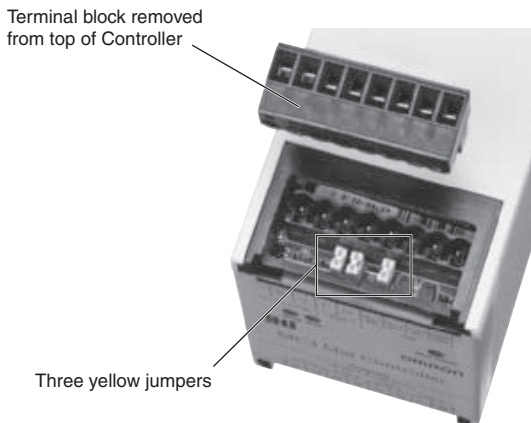

Dimensions

Safety Mat

1-cable mat

UM□□A-□-□-1

The UM□□A-□-□-1 mat comes with a short 4-conductor quick disconnect cables with M8 4-pin connector at a corner of the safety mat.

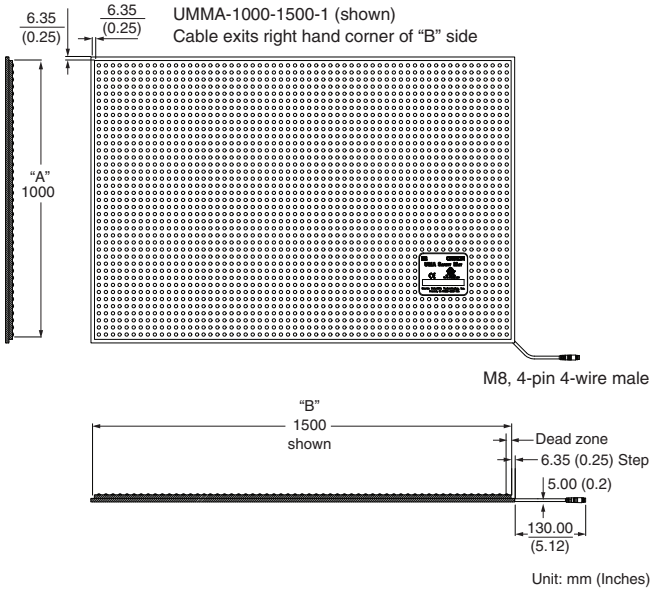

2-cable mat

UM@□□A-@-@-2

The UM□□A-□-□-2 mat comes with two short 2-conductor quick disconnect cables with M8 3-pin connector at two corners of the safety mat.

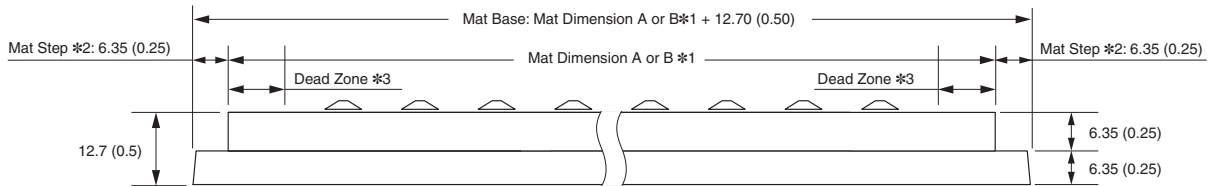
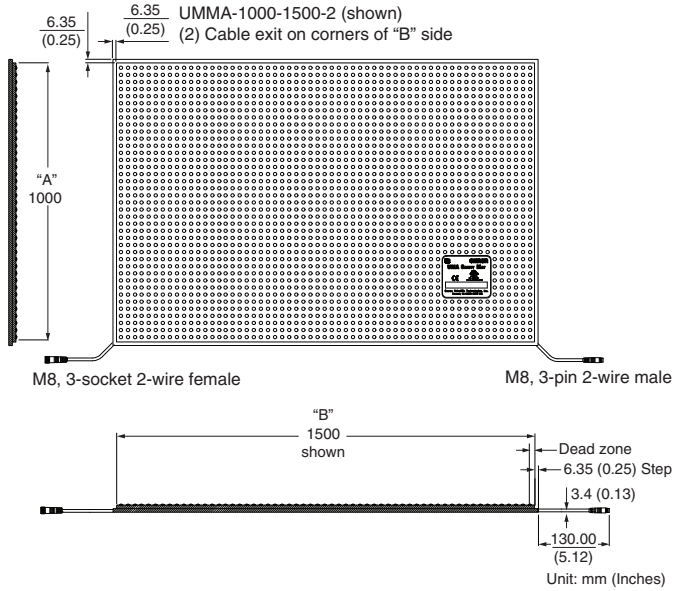

- *1. Refer to *Model Number Structure* on page 1 for more information.
- *2. "Step" portion of mat (inactive) is used to "seat/place/hold" trim.
- *3. The mat has the following inactive (non-sensing) area:
 - 10 mm (20 mm at corners) with a test piece of 80 mm diameter
 - 15 mm (30 mm at corners) with a test piece of 11 mm diameter

Example dimensions: UMMA-0500-0500-□

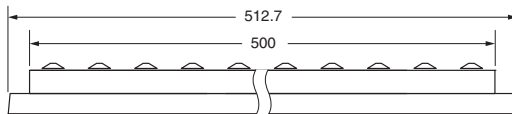

**Mat Controller
MC3**

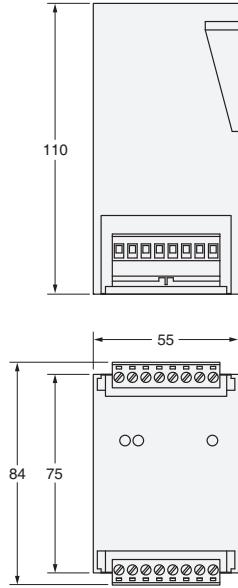

Terminal/LED arrangements

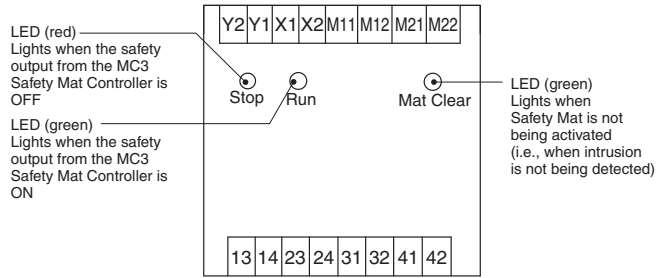

Accessories

Cables

Using with 1-Cable Mats

Single Connector Cable (M8, 4-socket)

Single connector cable to connect a 1-cable UMA Safety Mat to a MC3 Safety Mat Controller.

UMA-CBL-4PCF-M8-□M

Model	L (m)
UMA-CBL-4PCF-M8-02M	2
UMA-CBL-4PCF-M8-05M	5
UMA-CBL-4PCF-M8-10M	10

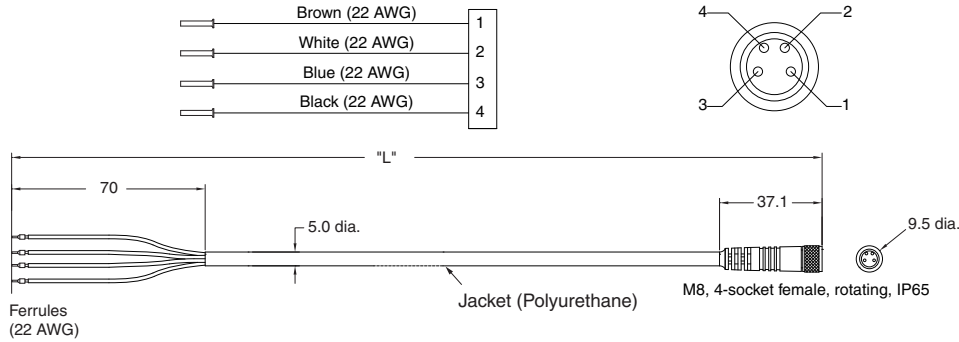

Male-Female Extension Cable (M8, 4-pin)

Extension cable to connect a 1-cable UMA Safety Mat to a UMA-CBL-4PCF-M8-□M Single Connector Cable.

UMA-CBL-4PMF-M8-□M

Model	L (m)
UMA-CBL-4PMF-M8-02M	2
UMA-CBL-4PMF-M8-05M	5
UMA-CBL-4PMF-M8-10M	10

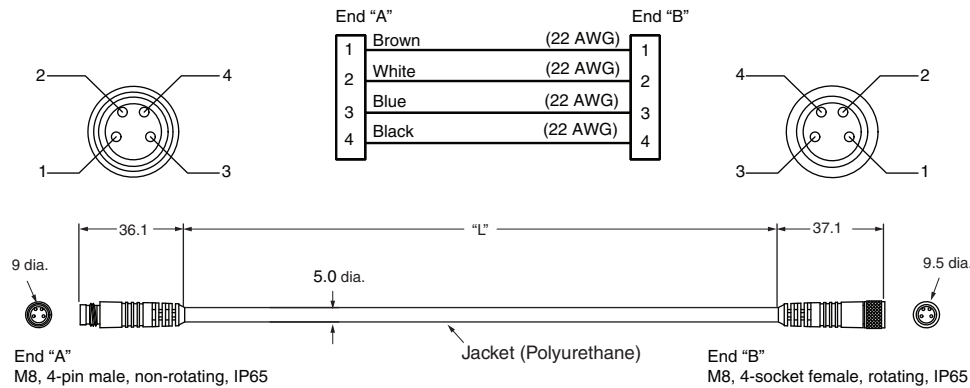

Using with 2-Cable Mats

Single Connector Cable (M8, 3-socket)

Single connector cable to connect a 2-cable UMA Safety Mat to a MC3 Safety Mat Controller.

UMA-CBL-3PCF-M8-□M

Model	L (m)
UMA-CBL-3PCF-M8-02M	2
UMA-CBL-3PCF-M8-05M	5
UMA-CBL-3PCF-M8-10M	10

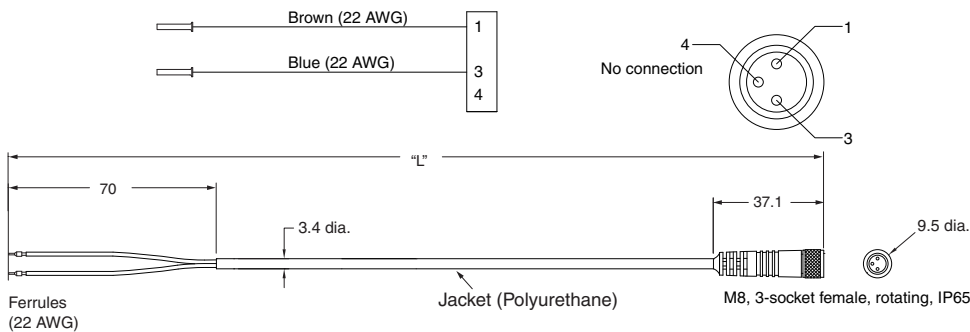

Male-Female Extension Cable (M8, 3-pin)

Extension cable to connect a 2-cable UMA Safety Mat to a UMA-CBL-3PCF-M8-□M Single Connector Cable or connect multiple 2-cable UMA Safety Mats in series.

UMA-CBL-3PMF-M8-□M

Model	L (m)
UMA-CBL-3PMF-M8-02M	2
UMA-CBL-3PMF-M8-05M	5
UMA-CBL-3PMF-M8-10M	10

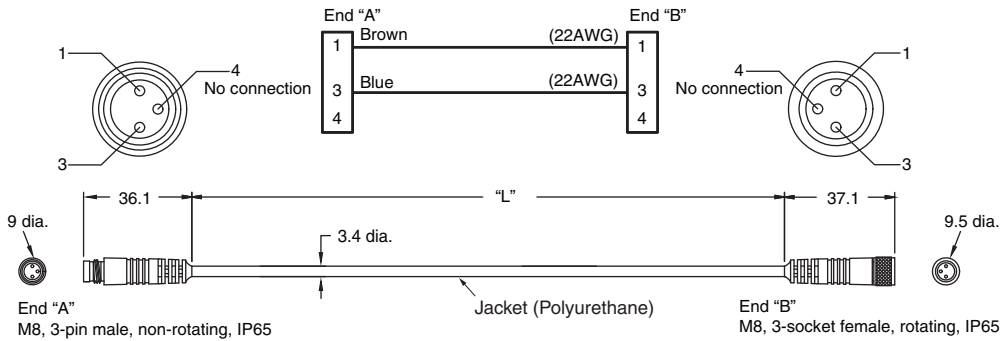

Male-Male Extension Cable (M8, 3-pin)

Used to connect the connector sockets of 2-cable UMA Safety Mats together.

UMA-CBL-3PMM-M8-0.15M

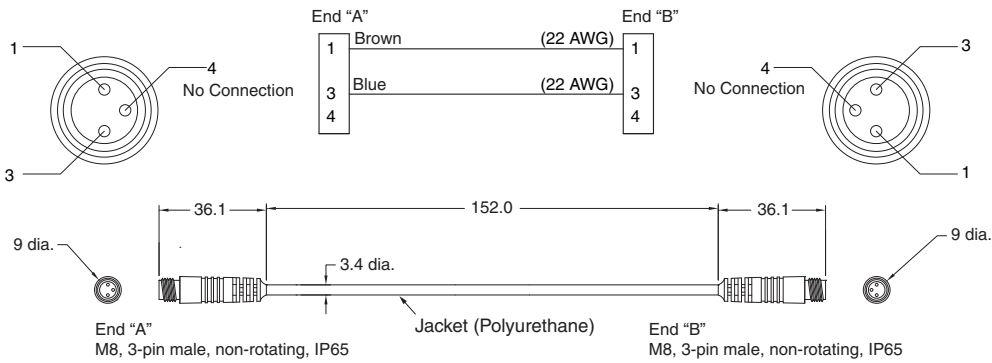

Female-Female Extension Cable (M8, 3-pin)

Used to connect the connector plugs of 2-cable UMA Safety Mats together.

UMA-CBL-3PFF-M8-0.15M

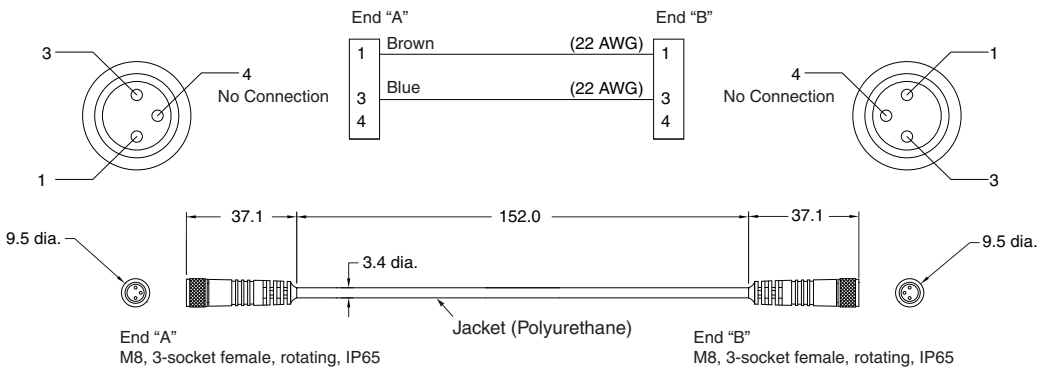

Trims

Ramp Trim with Yellow PVC Cover
UMRT

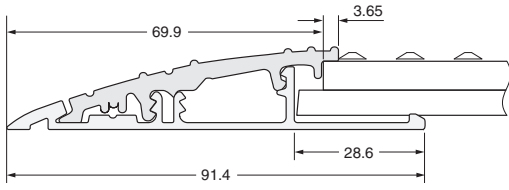

Joining Trim
UMJS

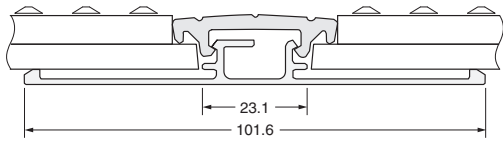

Aluminum Ramp Trim
UMAL

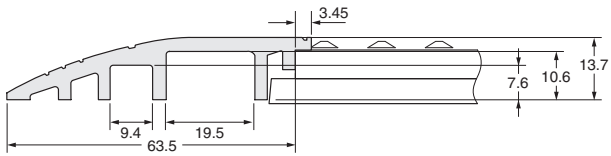

Molded Outside Corner
UMOC

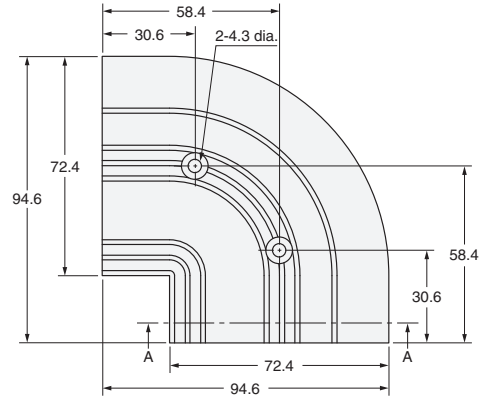

Molded Inside Corner
UMIC

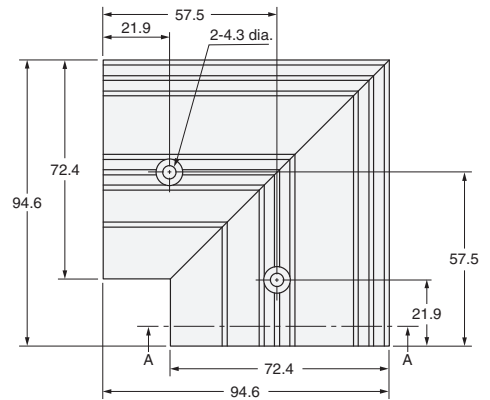

UMA

Application Examples

PL/safety category	Model	Stop category	Reset
PLd/3 equivalent	Safety Mat UMA series (1-cable mat) Mat Controller MC3	0	Manual

Note: The above PL is only the evaluation result of the example. The PL must be evaluated in an actual application by the customer after confirming the usage conditions.

Application Overview

- The power supply to the motor M is turned OFF when a person steps on the mat.
- The power supply to the motor M is kept OFF until the reset switch S1 is pressed after a person steps out of the mat and the guard is closed.

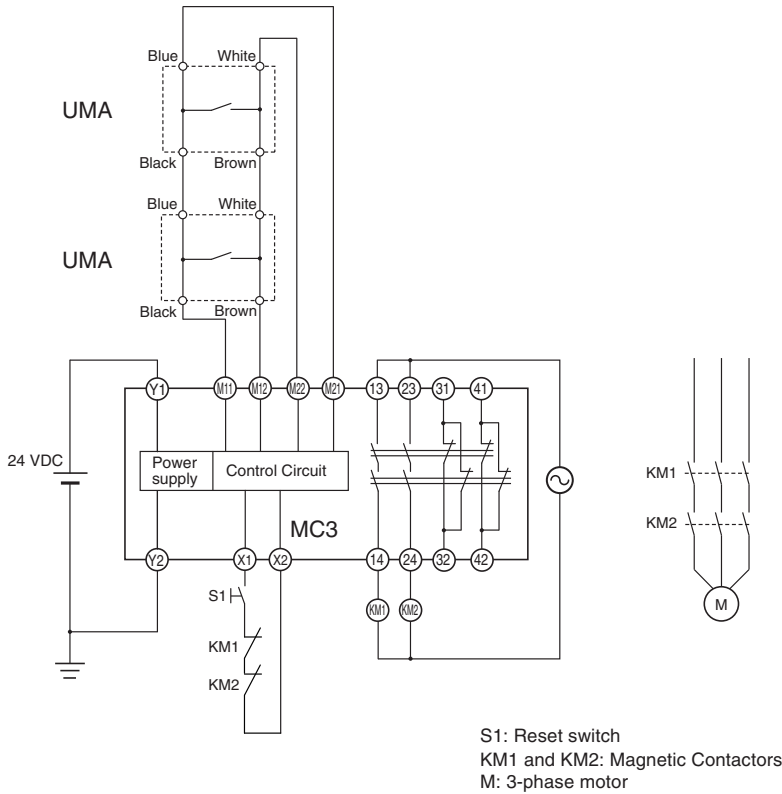

Timing Chart

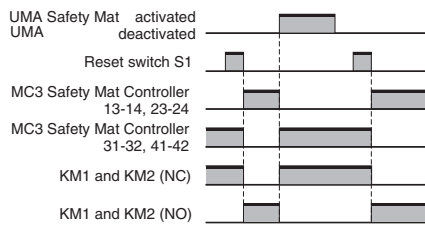

Note: Remove the three yellow jumpers from the MC3 to use Manual Reset Mode. Refer to *Mat Controller MC3 Series Installation and Operating Manual* for the location of the jumpers.

PL/safety category	Model	Stop category	Reset
PLd/3 equivalent	Safety Mat UMA series (2-cable mat) Mat Controller MC3	0	Auto

Note: The above PL is only the evaluation result of the example. The PL must be evaluated in an actual application by the customer after confirming the usage conditions.

Application Overview

- The power supply to the motor M is turned OFF when a person steps on the mat.
- The power supply to the motor M is turned OFF when the S1 detects that the guard is opened.
- The power supply to the motor M is kept OFF until a person steps out of the mat and the guard is closed.

(Other safety relay units or safety controllers than the G9SB can also be used for this application.)

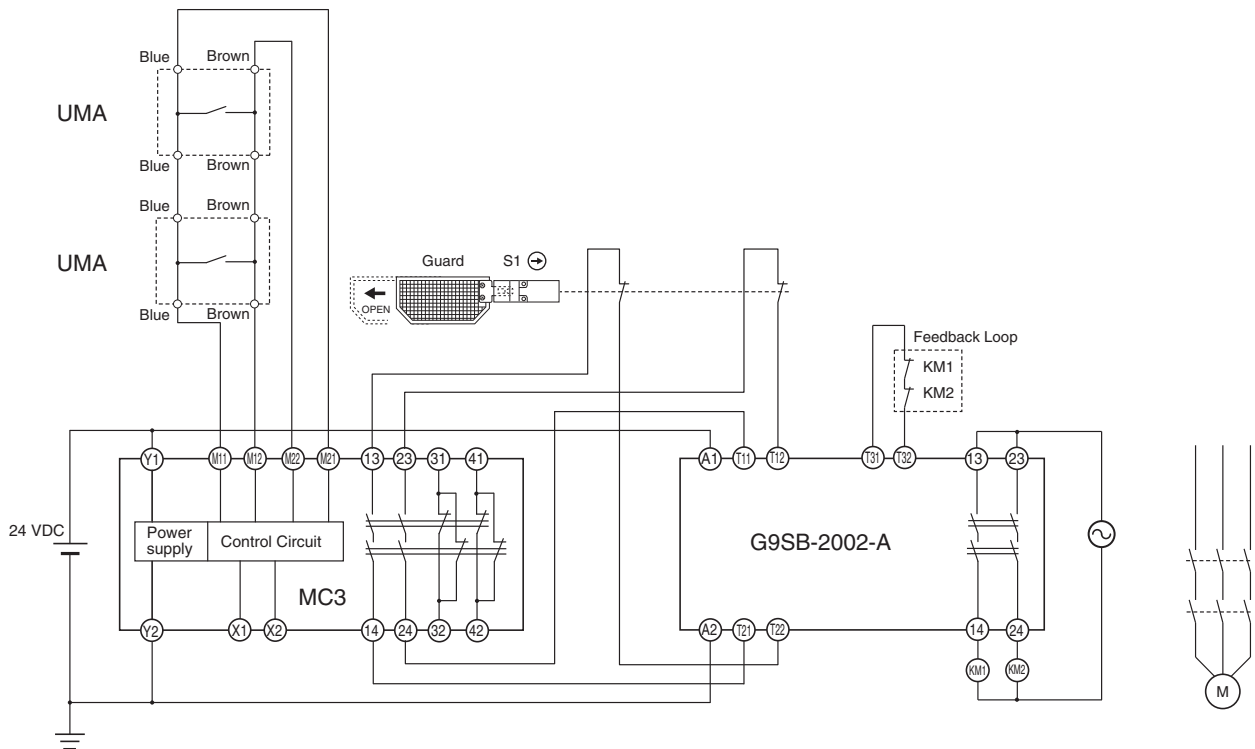

S1: Safety door switch
 KM1 and KM2: Magnetic Contactors
 M: 3-phase motor

Timing Chart

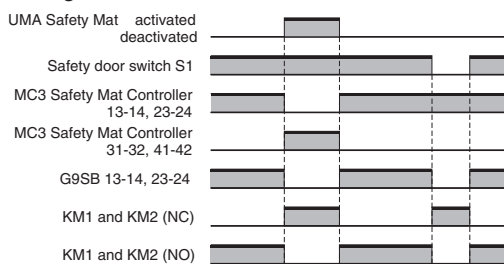

Note: Attach the three yellow jumpers to the MC3 to use Automatic Reset Mode. Refer to *Mat Controller MC3 Series Installation and Operating Manual* for the location of the jumpers.

Related Manuals

Man. No.	Model	Manual name
Z375-E1	UMA	UMA Safety Mat User Manual

Terms and Conditions Agreement

Read and understand this catalog.

Please read and understand this catalog before purchasing the products. Please consult your OMRON representative if you have any questions or comments.

Warranties.

- (a) Exclusive Warranty. Omron's exclusive warranty is that the Products will be free from defects in materials and workmanship for a period of twelve months from the date of sale by Omron (or such other period expressed in writing by Omron). Omron disclaims all other warranties, express or implied.
- (b) Limitations. OMRON MAKES NO WARRANTY OR REPRESENTATION, EXPRESS OR IMPLIED, ABOUT NON-INFRINGEMENT, MERCHANTABILITY OR FITNESS FOR A PARTICULAR PURPOSE OF THE PRODUCTS. BUYER ACKNOWLEDGES THAT IT ALONE HAS DETERMINED THAT THE PRODUCTS WILL SUITABLY MEET THE REQUIREMENTS OF THEIR INTENDED USE.

Omron further disclaims all warranties and responsibility of any type for claims or expenses based on infringement by the Products or otherwise of any intellectual property right. (c) Buyer Remedy. Omron's sole obligation hereunder shall be, at Omron's election, to (i) replace (in the form originally shipped with Buyer responsible for labor charges for removal or replacement thereof) the non-complying Product, (ii) repair the non-complying Product, or (iii) repay or credit Buyer an amount equal to the purchase price of the non-complying Product; provided that in no event shall Omron be responsible for warranty, repair, indemnity or any other claims or expenses regarding the Products unless Omron's analysis confirms that the Products were properly handled, stored, installed and maintained and not subject to contamination, abuse, misuse or inappropriate modification. Return of any Products by Buyer must be approved in writing by Omron before shipment. Omron Companies shall not be liable for the suitability or unsuitability or the results from the use of Products in combination with any electrical or electronic components, circuits, system assemblies or any other materials or substances or environments. Any advice, recommendations or information given orally or in writing, are not to be construed as an amendment or addition to the above warranty.

See <http://www.omron.com/global/> or contact your Omron representative for published information.

Limitation on Liability; Etc.

OMRON COMPANIES SHALL NOT BE LIABLE FOR SPECIAL, INDIRECT, INCIDENTAL, OR CONSEQUENTIAL DAMAGES, LOSS OF PROFITS OR PRODUCTION OR COMMERCIAL LOSS IN ANY WAY CONNECTED WITH THE PRODUCTS, WHETHER SUCH CLAIM IS BASED IN CONTRACT, WARRANTY, NEGLIGENCE OR STRICT LIABILITY.

Further, in no event shall liability of Omron Companies exceed the individual price of the Product on which liability is asserted.

Suitability of Use.

Omron Companies shall not be responsible for conformity with any standards, codes or regulations which apply to the combination of the Product in the Buyer's application or use of the Product. At Buyer's request, Omron will provide applicable third party certification documents identifying ratings and limitations of use which apply to the Product. This information by itself is not sufficient for a complete determination of the suitability of the Product in combination with the end product, machine, system, or other application or use. Buyer shall be solely responsible for determining appropriateness of the particular Product with respect to Buyer's application, product or system. Buyer shall take application responsibility in all cases.

NEVER USE THE PRODUCT FOR AN APPLICATION INVOLVING SERIOUS RISK TO LIFE OR PROPERTY OR IN LARGE QUANTITIES WITHOUT ENSURING THAT THE SYSTEM AS A WHOLE HAS BEEN DESIGNED TO ADDRESS THE RISKS, AND THAT THE OMRON PRODUCT(S) IS PROPERLY RATED AND INSTALLED FOR THE INTENDED USE WITHIN THE OVERALL EQUIPMENT OR SYSTEM.

Programmable Products.

Omron Companies shall not be responsible for the user's programming of a programmable Product, or any consequence thereof.

Performance Data.

Data presented in Omron Company websites, catalogs and other materials is provided as a guide for the user in determining suitability and does not constitute a warranty. It may represent the result of Omron's test conditions, and the user must correlate it to actual application requirements. Actual performance is subject to the Omron's Warranty and Limitations of Liability.

Change in Specifications.

Product specifications and accessories may be changed at any time based on improvements and other reasons. It is our practice to change part numbers when published ratings or features are changed, or when significant construction changes are made. However, some specifications of the Product may be changed without any notice. When in doubt, special part numbers may be assigned to fix or establish key specifications for your application. Please consult with your Omron's representative at any time to confirm actual specifications of purchased Product.

Errors and Omissions.

Information presented by Omron Companies has been checked and is believed to be accurate; however, no responsibility is assumed for clerical, typographical or proofreading errors or omissions.

OMRON Corporation Industrial Automation Company
Kyoto, JAPAN

Contact: www.ia.omron.com

Regional Headquarters

OMRON EUROPE B.V.
Wegalaan 67-69, 2132 JD Hoofddorp
The Netherlands
Tel: (31)2356-81-300/Fax: (31)2356-81-388

OMRON ELECTRONICS LLC
2895 Greenspoint Parkway, Suite 200
Hoffman Estates, IL 60169 U.S.A.
Tel: (1) 847-843-7900/Fax: (1) 847-843-7787

OMRON ASIA PACIFIC PTE. LTD.
No. 438A Alexandra Road # 05-05/08 (Lobby 2),
Alexandra Technopark,
Singapore 119967
Tel: (65) 6835-3011/Fax: (65) 6835-2711

OMRON (CHINA) CO., LTD.
Room 2211, Bank of China Tower,
200 Yin Cheng Zhong Road,
PuDong New Area, Shanghai, 200120, China
Tel: (86) 21-5037-2222/Fax: (86) 21-5037-2200

Authorized Distributor:

© OMRON Corporation 2017 All Rights Reserved.
In the interest of product improvement,
specifications are subject to change without notice.

Cat. No. **A250-E2-01-X**

0317